



INVERTER

Option unit

**FR-PU07(-01)**

INSTRUCTION MANUAL

---

*Parameter unit*

---



PRE-OPERATION INSTRUCTIONS **1**

FUNCTIONS **2**

FUNCTION MENU **3**

OPERATION **4**

CHECK FIRST WHEN YOU  
HAVE A TROUBLE **5**

SPECIFICATIONS **6**

Thank you for choosing the Mitsubishi inverter option unit. This instruction manual gives handling information and precautions for use of this equipment. Incorrect handling might cause an unexpected fault. Before using the equipment, please read this manual carefully to use the equipment to its optimum. Please forward this manual to the end user.

## This section is specifically about safety matters

Do not attempt to install, operate, maintain or inspect this product until you have read through this instruction manual and appended documents carefully and can use the equipment correctly. Do not use this product until you have a full knowledge of the equipment, safety information and instructions.

In this instruction manual, the safety instruction levels are classified into "WARNING" and "CAUTION".



Assumes that incorrect handling may cause hazardous conditions, resulting in death or severe injury.



Assumes that incorrect handling may cause hazardous conditions, resulting in medium or slight injury, or may cause physical damage only.

Note that the  CAUTION level may lead to a serious consequence according to conditions. Please follow the instructions of both levels because they are important to personnel safety.

---

## SAFETY INSTRUCTIONS

---

### 1. Electric Shock Prevention

#### WARNING

- Do not run the inverter with the front cover removed. Otherwise, you may access exposed high voltage terminals or charging devices and get an electric shock.
- Before starting wiring or inspection, check that the operation panel indicator is OFF, wait for at least 10 minutes after the power supply has been switched OFF, and check that there are no residual voltage using a tester or the like. The capacitor is charged with high voltage for some time after power OFF and it is dangerous.
- Any person who is involved in the wiring or inspection of this equipment should be fully competent to do the work.
- Always install the inverter before wiring. Otherwise, you may get an electric shock or be injured.
- Operate the keys with dry hands to prevent an electric shock.

## 2. Additional Instructions

To prevent injury, damage or product failure, please note the following points.

### (1) Transportation and mounting

#### CAUTION

- Do not install and operate the parameter unit (FR-PU07) if it is damaged or has parts missing.
- Do not stand or rest heavy objects on this equipment.
- Check the inverter mounting orientation is correct.
- The parameter unit (FR-PU07) is a precision device. Do not drop it or subject it to impact.
- Use the inverter under the following environmental conditions:

Environment	Surrounding air temperature	-10°C to +50°C (non-freezing)
	Ambient humidity	90%RH or less (non-condensing)
	Storage temperature	-20°C to +65°C*
	Ambience	Indoors (free from corrosive gas, flammable gas, oil mist, dust and dirt)
	Altitude, vibration	Maximum 1000m above seal level, 5.9m/s <sup>2</sup> or less at 10 to 55Hz (directions of X, Y, Z axes)

\*Temperatures applicable for a short time, e.g. in transit.

### (2) Test operation and adjustment

#### CAUTION

- Before starting operation, confirm and adjust the parameters. A failure to do so may cause some machines to make unexpected motions.

### (3) Usage

#### WARNING

- Since pressing  key may not stop output depending on the function setting status, provide a circuit and switch separately to make an emergency stop (power OFF, mechanical brake operation for emergency stop, etc).
- Make sure that the start signal is off before resetting the inverter alarm. A failure to do so may restart the motor suddenly.
- Do not modify the equipment.
- Do not perform parts removal which is not instructed in this manual. Doing so may lead to fault or damage of the inverter.

#### CAUTION

- When parameter clear or all parameter clear is performed, each parameter returns to the factory setting. Re-set the required parameters before starting operation.

### (4) Corrective actions for alarm

#### CAUTION

- Provide safety backup devices, such as an emergency brake, to protect machines and equipment from hazard if the parameter unit (FR-PU07) becomes faulty.

### (5) Disposal

#### CAUTION

- Treat as industrial waste.

### (6) General instruction

All illustrations given in this manual may have been drawn with covers or safety guards removed to provide in-depth description. Before starting operation of the product, always return the covers and guards into original positions as specified and operate the equipment in accordance with the manual.

# — CONTENTS —

<b>INTRODUCTION</b>	<b>1</b>
<hr/>	
<b>1 PRE-OPERATION INSTRUCTIONS</b>	<b>2</b>
<hr/>	
<b>1.1 Supporting inverter models</b> .....	<b>2</b>
<b>1.2 Unpacking and Product Confirmation</b> .....	<b>3</b>
1.2.1 Appearance and parts identification .....	3
1.2.2 Explanation of keys .....	4
<b>1.3 Installation and Removal of FR-PU07</b> .....	<b>6</b>
1.3.1 Direct installation to the inverter (A700/F700 series).....	6
1.3.2 Removal from the inverter (A700/F700 series).....	7
1.3.3 Installation using the connection cable (FR-CB2) .....	8
1.3.4 Removal when the connection cable (FR-CB2) is used .....	10
<b>1.4 Parameters to be Checked First</b> .....	<b>11</b>
1.4.1 PU display language selection (Pr. 145) .....	11
1.4.2 PU buzzer control (Pr. 990).....	11
1.4.3 PU contrast adjustment (Pr. 991) .....	12
<b>2 FUNCTIONS</b>	<b>13</b>
<hr/>	
<b>2.1 Monitoring Function</b> .....	<b>13</b>
2.1.1 Display overview.....	13
2.1.2 Using "SHIFT" to change the main monitor .....	15

2.1.3	Setting the power-ON monitor (the first priority monitor).....	16
2.1.4	Using "READ" to change the main monitor .....	17
2.1.5	Using the parameter to change the monitor (Pr. 52) .....	18
<b>2.2</b>	<b>Frequency Setting.....</b>	<b>20</b>
2.2.1	Direct setting.....	20
2.2.2	Step setting.....	21
2.2.3	Precautions for frequency setting .....	22
<b>2.3</b>	<b>Setting and Changing the Parameter Values .....</b>	<b>23</b>
2.3.1	Specifying the parameter number to change the set value .....	23
2.3.2	Selecting the parameter from functional list to change the set value .....	24
2.3.3	Selecting the parameter from parameter list to change the set value .....	26
2.3.4	Selecting the parameter from User List to change the set value.....	27
2.3.5	Precautions for setting write .....	28
<b>2.4</b>	<b>User Group Function .....</b>	<b>29</b>
2.4.1	Registering the parameters to user group.....	30
2.4.2	Deleting the parameters from user group.....	31
2.4.3	Confirming the parameters registered to user group.....	31
<b>2.5</b>	<b>Calibration of the Meter (Frequency Meter).....</b>	<b>32</b>
2.5.1	Calibration of the FM terminal .....	32
2.5.2	Calibration of the AM terminal .....	33
<b>2.6</b>	<b>Adjustment of the Frequency Setting Signals "Bias" and "Gain" .....</b>	<b>36</b>
2.6.1	Adjustment procedure .....	36

### **3 FUNCTION MENU**

**43**

<b>3.1 Overview of Function Menu</b> .....	<b>43</b>
3.1.1 Function menu .....	43
3.1.2 Function menu transition .....	45
<b>3.2 Operation Procedures for Functions</b> .....	<b>49</b>
3.2.1 Monitor function .....	49
3.2.2 Selection of PU operation (direct input).....	50
3.2.3 Selection of the PU Jog operation mode .....	51
3.2.4 Parameters .....	52
3.2.5 Parameter clear .....	55
3.2.6 Alarm history.....	57
3.2.7 Alarm clear .....	58
3.2.8 Inverter reset .....	59
3.2.9 Troubleshooting.....	60
3.2.10 Terminal assignment (Selectop).....	64
3.2.11 Option .....	65
3.2.12 Multiple copies.....	66
<b>3.3 Other Precautions</b> .....	<b>71</b>
3.3.1 Precautions for parameter unit operation .....	71

## **4 OPERATION** **72**

---

<b>4.1 How to Select the Operation Mode</b> .....	<b>72</b>
4.1.1 Switching from External operation mode [EXT] to PU operation mode [PU].....	72
4.1.2 Switching from PU operation mode [PU] to External operation mode [EXT].....	72
4.1.3 Switching to the External / PU combined operation mode .....	73

<b>4.2</b>	<b>How to Operate PU Operation .....</b>	<b>74</b>
4.2.1	Normal operation .....	74
4.2.2	PU Jog operation .....	75
<b>4.3</b>	<b>Combined Operation (Operation Using External Input Signals and PU) .....</b>	<b>76</b>
4.3.1	Entering the start signal from outside and setting the running frequency from the PU (Pr. 79 = 3) .....	76
4.3.2	Entering the running frequency from outside and making start and stop from the PU (Pr. 79 = 4) .....	77
4.3.3	Entering the start signal and multi-speed signal from outside and setting multiple speeds from the parameter unit .....	78
<b>5</b>	<b>CHECK FIRST WHEN YOU HAVE A TROUBLE .....</b>	<b>79</b>
<b>5.1</b>	<b>Troubleshooting .....</b>	<b>79</b>
<b>6</b>	<b>SPECIFICATIONS .....</b>	<b>80</b>
<b>6.1</b>	<b>Standard Specifications .....</b>	<b>80</b>
<b>6.2</b>	<b>Outline Drawing and Panel Cutting Drawing .....</b>	<b>81</b>
6.2.1	FR-PU07 outline dimension drawings .....	81
	<b>APPENDIX .....</b>	<b>82</b>
	<b>Appendix 1 Disposing of the equipment in the EU countries .....</b>	<b>82</b>

# INTRODUCTION

This product is a unit for setting inverter functions (parameters) and has the following features.

- An operation panel can be removed and a parameter unit can be connected.
- Setting such as direct input method with a numeric keypad, operation status indication, and help function are usable.
- Eight languages can be displayed.
- Parameter setting values of maximum of three inverters can be stored.

The parameter unit screen displays in this instruction manual are examples used with the FR-A700 series.



# 1 PRE-OPERATION INSTRUCTIONS

## 1.1 Supporting inverter models

(1) FR-PU07(-01) supporting models

Model	FR-PU07	FR-PU07-01
A700 series	○	×
F700 series	○	○ *3
E700 series	○ *2	×
D700 series	○ *2	×
500 series	○ *1, *2	×

○:supported







× :not supported

- \*1 Some parameter names displayed are different from those of the FR-PU07.
- \*2 The FR-PU07 cannot be directly connected to the inverter. To connect to the inverter, the dedicated cable is required.
- \*3 The following functions are available when using FR-PU07-01. To check the compatibility with FR-PU07-01, refer to the Instruction Manual of the inverter.

Refer to the inverter instruction manual for details of the following functions, changes of the operation key name and the operation mode indication on LCD. (The functions in this instruction manual are also available with FR-PU07-01.)

- PID display bias/gain setting menu
- Unit selection for the PID parameter/PID monitored items
- PID set point direct setting mode
- Monitor name display on 3-line monitor

The operation key name and the operation mode indication on LCD of FR-PU07-01 are different with FR-PU07. (When using FR-PU07-01, assume that the operation key name and the operation mode indication on LCD are changed as the following table.)

Operation key		Operation mode indication on LCD			
FR-PU07-01	FR-PU07	FR-PU07-01		FR-PU07	
AUTO key, HAND key	EXT key, PU key	Indication of AUTO, HAND		Indication of EXT, PU	
					

## 1.2 Unpacking and Product Confirmation







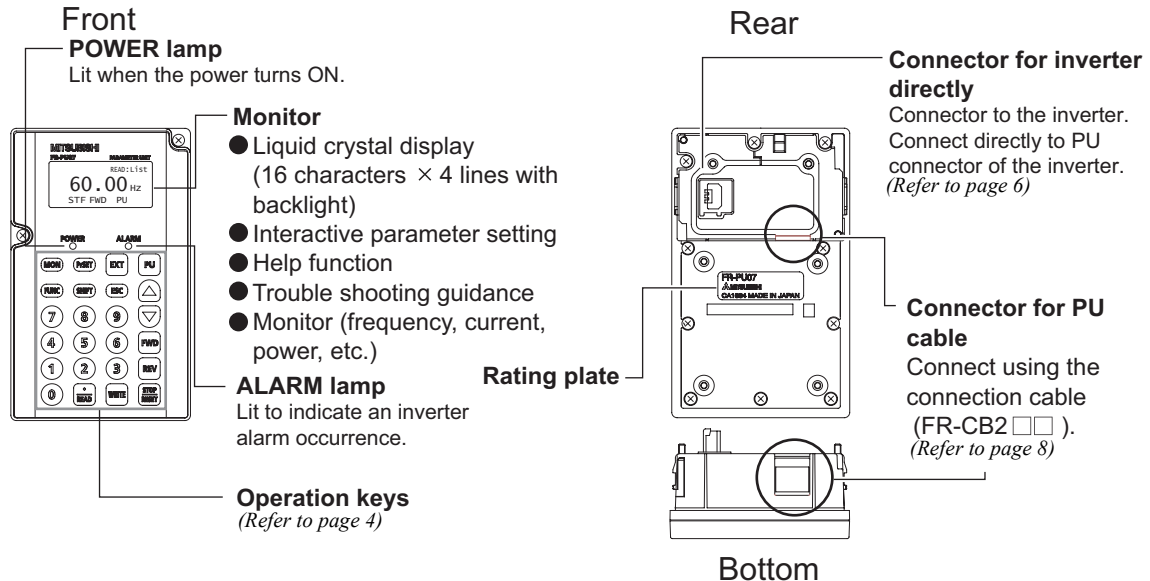

Take the parameter unit out of the package, check the unit name, and confirm that the product is as you ordered and intact.



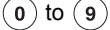

### 1.2.1 Appearance and parts identification

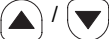
Unpack the parameter unit, check the name plate on the back, and make sure that the product has not been damaged before using.



### 1.2.2 Explanation of keys

Key	Description
	Used to select the parameter setting mode. Press to select the parameter setting mode.
	Used to display the first priority screen. Used to display the output frequency when making an initial setting.
	Operation cancel key.
	Used to display the function menu. A variety of functions can be used on the function menu.
	Used to shift to the next item in the setting or monitoring mode.
	Used to enter a frequency, parameter number or set value.
	Used to select the External operation mode.
	Used to select the PU operation mode to display the frequency setting screen.
	<ul style="list-style-type: none"><li>· Used to keep on increasing or decreasing the running frequency. Hold down to change the frequency.</li><li>· Press either of these keys on the parameter setting mode screen to change the parameter setting value sequentially.</li><li>· On the selecting screen, these keys are used to move the cursor.</li><li>· Hold down  and press either of these keys to advance or return the display screen one page.</li></ul>

Key	Description
	Forward rotation command key.
	Reverse rotation command key.
	<ul style="list-style-type: none"> <li>· Stop command key.</li> <li>· Used to reset the inverter when a fault occurs.</li> </ul>
	<ul style="list-style-type: none"> <li>· Used to write a set value in the setting mode.</li> <li>· Used as a clear key in the all parameter clear or alarm history clear mode.</li> </ul>
	<ul style="list-style-type: none"> <li>· Used as a decimal point when entering numerical value.</li> <li>· Used as a parameter number read key in the setting mode.</li> <li>· Used as an item select key on the menu screen such as parameter list or monitoring list.</li> <li>· Used as an alarm definition display key in the alarm history display mode.</li> <li>· Used as a command voltage read key in the calibration mode.</li> </ul>

1

---



---

### CAUTION

---



---

- Do not use a sharp-pointed tool to push the keys.
  - Do not press your fingers against the display.
- 
-

### 1.3 Installation and Removal of FR-PU07

To ensure safety, install or remove FR-PU07 after switching the power of the inverter OFF.  
FR-PU07 cannot be directly installed to the FR-E700, D700 inverter.

#### 1.3.1 Direct installation to the inverter (A700/F700 series)

- (1) Remove the operation panel (FR-DU07).
- (2) Insert the parameter unit straight and fit it securely.
- (3) Tighten the two screws on the parameter unit to fix the unit to the inverter.

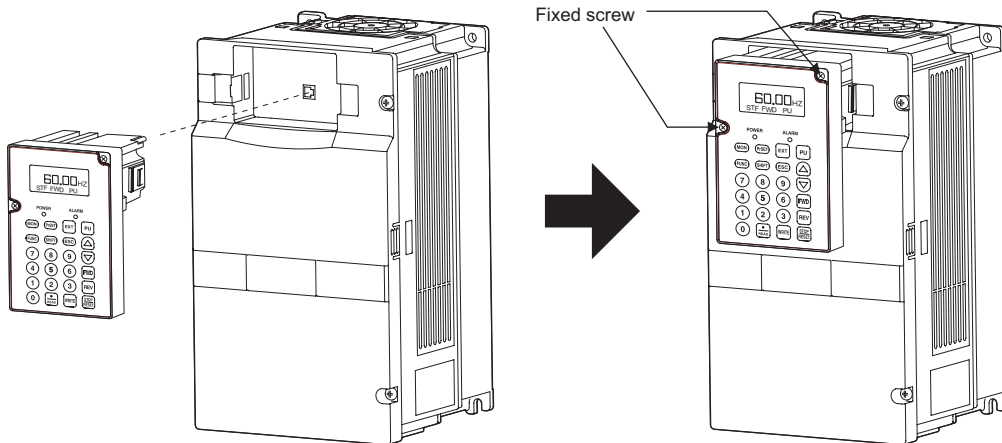

### 1.3.2 Removal from the inverter (A700/F700 series)

Loosen the fixed screws, hold down the right and left hooks of the FR-PU07, and then pull the parameter unit toward you.

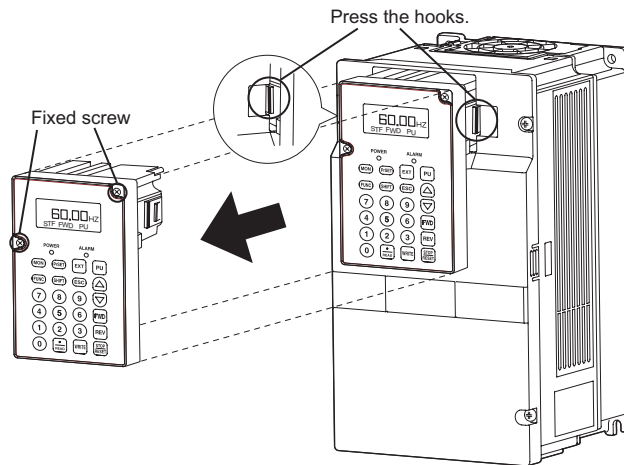

### 1.3.3 Installation using the connection cable (FR-CB2)

•For the FR-A700/FR-F700

- (1) Remove the operation panel (FR-DU07).
- (2) Securely insert one end of connection cable into the PU connector of the inverter and the other end into the connection connector of FR-PU07 along the guides until the stoppers are fixed.

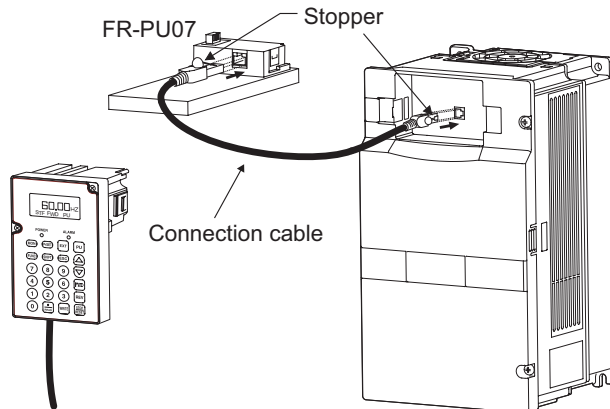

---

#### CAUTION

---

Do not connect the connection cable when the front cover is removed.

---

•For FR-E700

- (1) Open the PU connector cover.
- (2) Securely insert one end of connection cable into the PU connector of the inverter and the other end into the connection connector of FR-PU07 along the guides until the stoppers are fixed.

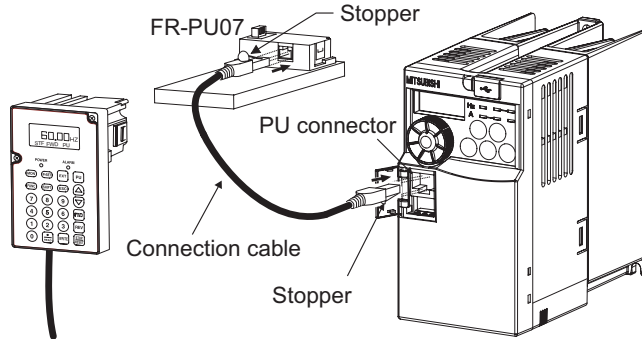

**CAUTION**

Do not connect the connection cable when the front cover is removed.

**REMARKS**

For details of the connection cable (FR-CB2), refer to the connection cable (FR-CB2) instruction manual.



### •For FR-D700

- (1) Remove the inverter front cover. (For the removal of the front cover, refer to the inverter manual.)
- (2) Securely insert one end of connection cable into the PU connector of the inverter and the other end into the connection connector of FR-PU07 along the guides until the stoppers are fixed.

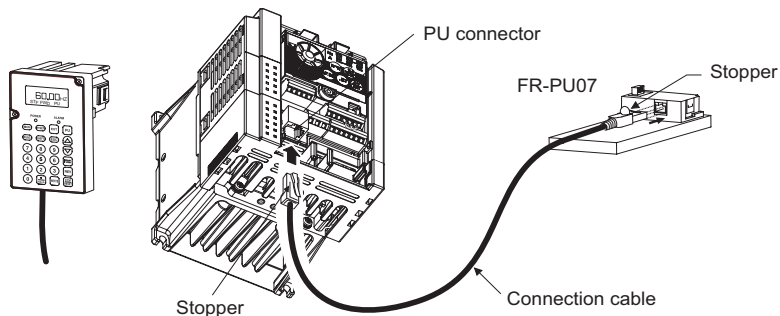

### CAUTION

Do not connect the connection cable when the front cover is removed.

### REMARKS

For details of the connection cable (FR-CB2), refer to the connection cable (FR-CB2) instruction manual.

### 1.3.4 Removal when the connection cable (FR-CB2) is used

Hold down the tab (stopper) at the cable end and gently pull the plug.

## 1.4 Parameters to be Checked First

Change the following parameter settings as required.

For the changing procedures, refer to *page 23*.

### 1.4.1 PU display language selection (Pr. 145)

By setting the *Pr. 145 PU display language selection* value, you can select the language displayed on the parameter unit.

<i>Pr. 145 Setting</i>	Display Language
0	Japanese
1 (initial value)	English
2	German
3	French
4	Spanish
5	Italian
6	Swedish
7	Finnish

### 1.4.2 PU buzzer control (Pr. 990)

By setting the *Pr. 990 PU buzzer control* value, you can select to either generate or mute the "beep" which sounds when you press any of the parameter unit keys.

<i>Pr. 990 Setting</i>	Description
0	No buzzer sound
1 (initial value)	Buzzer sound generated

### 1.4.3 PU contrast adjustment (Pr. 991)

By setting the *Pr. 991 PU contrast adjustment* value, you can adjust the contrast for the display panel of the parameter unit.

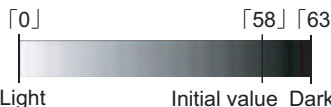
<i>Pr. 991</i> Setting	Description
0 to 63	 <p>「0」 [58] 「63」 Light Initial value Dark</p>

# 2 FUNCTIONS

## 2.1 Monitoring Function

### 2.1.1 Display overview

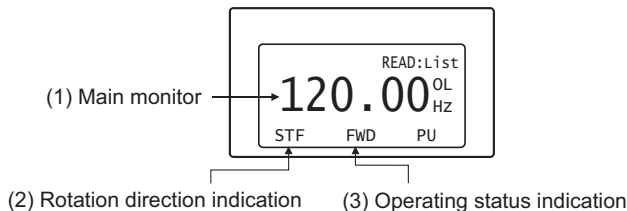

#### (1) Main monitor

Shows the output frequency, output current, output voltage, alarm history and other monitor data.

- Using **(SHIFT)** to change to the next screen (*Refer to page 15*)
- Using **(FUNC)** to change to the next screen (*Refer to page 49*)
- Using the parameter "PU main display data selection" (*Refer to page 18*)

#### (2) Rotation direction indication

Display the direction (forward rotation/reverse rotation) of the start command.

- STF : Forward rotation
- STR : Reverse rotation
- : No command or both STF and STR ON

#### (3) Operating status indication

Display the running status of the inverter.

- STOP : During stop
- FWD : During forward rotation
- REV : During reverse rotation
- JOGf : During Jog forward rotation
- JOGr : During Jog reverse rotation
- ARAR : At fault occurrence

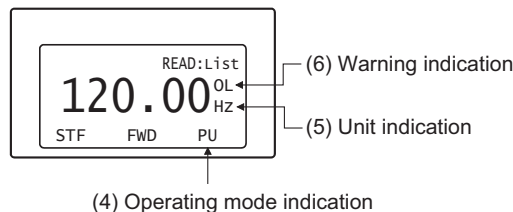

### (4) Operation mode indication

Displays the status of the operation mode.

- EXT : External operation mode
- PU : PU operation mode
- EXTj : External Jog mode
- PUj : PU Jog mode
- NET : Network operation mode
- PU+E : External/PU combined operation mode

### (5) Unit indication

Shows the unit of the main monitor.

### (6) Warning indication

Displays an inverter warning.

The warning type varies with the inverter model.  
Refer to the inverter instruction manual for details.

- OL : Overcurrent stall prevention
- oL : Overvoltage stall prevention
- RB : Regenerative brake pre-alarm
- TH : Electronic thermal relay function pre-alarm
- ZC : Zero current detection
- PS : PU stop
- FN : Fan fault
- MT : Maintenance signal output
- SL : Speed limit
- CF : SSCNET communication error
- CP : Parameter copy

Nothing is displayed when there is no inverter warning.

## 2.1.2 Using **SHIFT** to change the main monitor

When "0" (initial value) is set in the *Pr. 52 DU/PU main display data selection*, simply pressing **SHIFT** calls 6 different monitor screens in sequence.

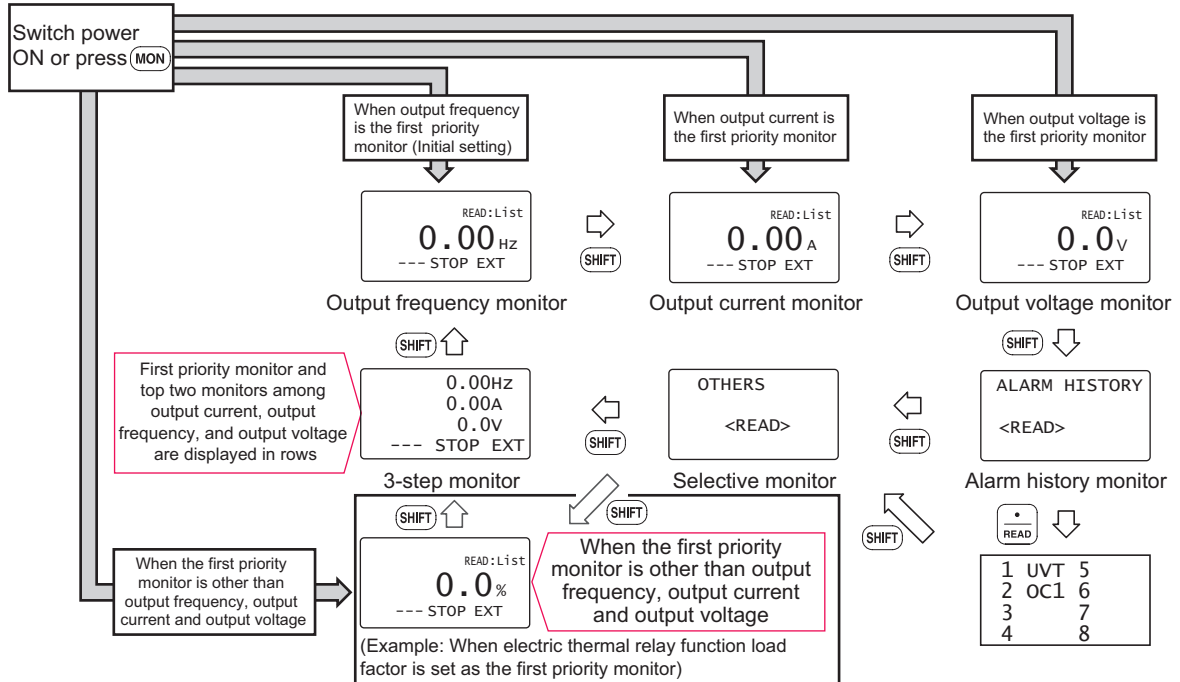

### **2.1.3** *Setting the power-ON monitor (the first priority monitor)*

Set the monitor which appears first when power is switched ON or **MON** is pressed.











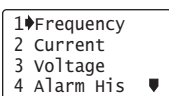

- When you press **WRITE** during any monitor screen other than ALARM HISTORY being displayed, that screen is set as the power-ON screen and will be displayed first.

## 2.1.4 Using to change the main monitor

Press  to display the monitoring list while the main monitor is displayed.

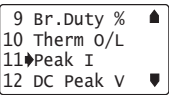

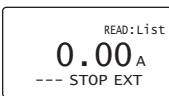
Select a monitor from the monitoring list to change the main monitor.

Example: Select the output current peak value monitor.

1	Press  . The parameter unit is in the monitoring mode.	
2	Press  . The monitoring list appears.	
3	Press  /  to move the cursor to "Peak I".  Hold down  and press  or  to shift one screen.	
4	Press  . *1 The output current peak is displayed.	
5	Press  . *2 The screen in step 4) is set as the first priority monitor.	Subsequently press  to call another monitor screen.

\*1 The selected monitor is not set as the first priority monitor yet when only  was pressed. Hence, the selected monitor is erased from memory as soon as the power is switched OFF or another operation mode is selected. In this case, the item

must be selected again. When you press  to select the first priority screen, the selected item is stored in memory.

\*2 Pressing  sets the selected "output current peak" to be displayed in the first priority monitor when switched to the monitoring mode from other operation modes. To give first priority to another monitor screen, press  with that monitor screen being displayed. (Refer to page 16)

### REMARKS

- The setting can be also made from the function menu. For details refer to page 43.
- When "Current monitor" or "Power monitor" is selected, note that any current or power not more than 5% of the rated inverter current cannot be detected and displayed.  
 Example: When a small motor is selected with a large-capacity inverter (a 0.4kW motor is used with a 55kW inverter), the power monitor keeps displaying 0kW and is inoperative.



### 2.1.5 Using the parameter to change the monitor (Pr. 52)

To change the third monitor (output voltage monitor), set *Pr. 52 DU/PU main display data selection*.

(Note that setting "17" (load meter) \*2, "18" (Motor excitation current) \*1 \*2, and "24" (Motor load ratio) change the output current monitor.

"Output voltage monitor" monitor displays from the first priority monitor using **SHIFT**.

\*1 Cannot be monitored for the FR-F700 series.

\*2 Cannot be monitored for the FR-E700, D700 series.

#### **REMARKS**

Refer to the instruction manual of each inverter for monitor description.

## Factory setting

\* The monitor displayed at powering ON is the first priority monitor. Refer to *page 16* for the setting method of the first priority monitor.

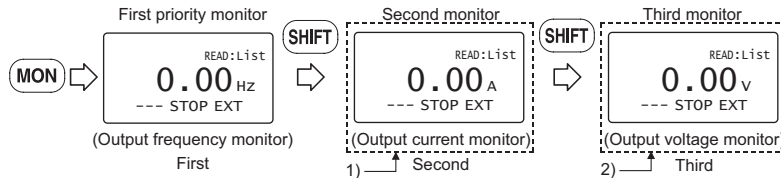

1) For the set value of "17, 18, 24", their monitors are displayed at the second monitor instead of output current monitor.

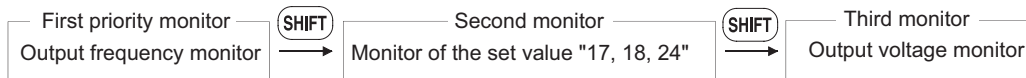

2) For the set value of "19 to 23, 25.....", their monitors are displayed at the third monitor instead of output voltage monitor.

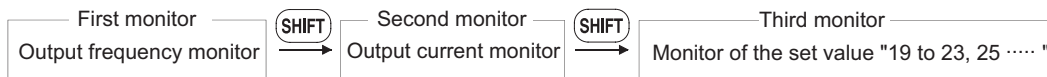

## REMARKS

The setting range of *Pr. 52 DU/PU main display data selection* differs according to the inverter. Refer to the inverter instruction manual for details.

## 2.2 Frequency Setting

The frequency in PU operation mode and External/PU combined operation mode (*Pr. 79 = "3"*) can be set.

### REMARKS

When changing the operation mode from External operation mode to PU operation mode, operation mode can not be changed if the external starting signal (STF or STR) is ON.

### 2.2.1 Direct setting

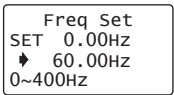
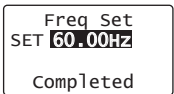

Directly enter a frequency setting using (0) to (9).

- Operation procedure (Changing from 0Hz setting to 60Hz setting)







1	Press <b>PU</b> . The frequency setting screen appears.	
2	Press (6) and (0). Enter 60Hz.	
3	Press <b>WRITE</b> . The 60Hz setting is complete.	

- \* If you entered an incorrect value, press (ESC) to return to the pre-entry state.

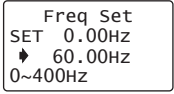

## 2.2.2 Step setting

Change frequency continuously using  / .

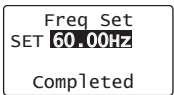
You can change the frequency only while you press  / . Since the frequency changes slowly at first, this setting can be used for fine adjustment.

1	Press  . The frequency setting screen appears.	
2	Press  /  to enter a desired value (60.00Hz). You can set any value between the maximum frequency ( <i>Pr: 1</i> ) and minimum frequency ( <i>Pr: 2</i> ).	
3	Press  . The 60Hz setting is complete.	

### REMARKS

Change of frequency can be made during operation by the step setting. However, pressing  /  at monitor mode may cause actual set frequency to be higher/lower from the indicated frequency on the monitor. When performing the step setting at monitor mode, make sure that output frequency is following the set frequency.

### 2.2.3 Precautions for frequency setting

- 1) Pr. 79 Operation mode selection must have been set to switch to the PU operation. (Refer to the inverter instruction manual for details of Pr. 79 .)
- 2) In the monitor mode, you cannot make the direct setting (Refer to page 20) to set the running frequency. Perform the step setting (Refer to page 21) and press **WRITE**, or press **PU** to display the frequency setting screen before frequency setting.

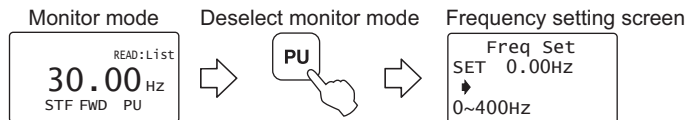



## 2.3 Setting and Changing the Parameter Values

Using the FR-PU07 allows you to read the parameter of inverter or change the set value easily. Refer to the inverter instruction manual for details of the parameters.

### 2.3.1 Specifying the parameter number to change the set value

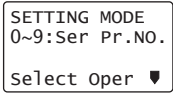
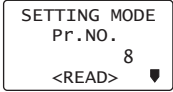
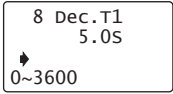
Example: When changing 5s to 180s at the *Pr. 8 Deceleration time* setting

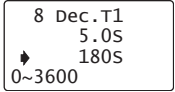
1	<p>Press <b>PU</b>.</p> <p>The frequency setting screen appears, and operation mode changes to PU operation mode.</p> <p>(You need not press <b>PU</b> when the parameter unit is already in the PU operation mode.)</p>	
2	<p>Press <b>PrSET</b>.</p> <p>The parameter unit is in the parameter setting mode.</p>	
3	<p>Press <b>8</b>.</p> <p>Enter the desired parameter number.</p>	
4	<p>Press <b>READ</b>.</p> <p>The present setting appears.</p>	

5	<p>(1) Direct setting</p> <p>Press <b>1 8 0</b>.*</p> <p>Enter the desired value.</p> <p>Or</p> <p>(2) Step setting</p> <p>Press <b>▲ ▼</b>.</p> <p>Display "180" using <b>▲ ▼</b>.</p>	
6	<p>Press <b>WRITE</b>.</p> <p>The set value is changed.</p>	
7	<p>Press <b>SHIFT</b> to display the next parameter.</p>	









\* If you entered an incorrect value, press **ESC** to return to the pre-entry state.

### 2.3.2 Selecting the parameter from functional list to change the set value

Example: When changing 5s to 180s at the Pr. 8  
Deceleration time setting

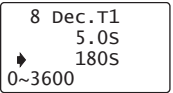
<b>1</b>	<p>Press <b>PU</b>.</p> <p>The frequency setting screen appears, and operation mode changes to PU operation mode.</p>	<pre> Freq Set SET 0.00Hz ♦ 0~400Hz                     </pre>
<b>2</b>	<p>Press <b>PrSET</b>.</p> <p>The parameter unit is in the parameter setting mode.</p>	<pre> SETTING MODE 0~9:Ser Pr.NO. Select Oper ▼                     </pre>
<b>3</b>	<p>Select the screen using <b>▼</b> and move the cursor to "Appl.Grp".</p>	<pre> 1♦Appl.Grp ▲ 2 Pr.List 3 User List 4 Param Copy                     </pre>
<b>4</b>	<p>Press <b>READ</b>.</p> <p>The function list appears.</p>	<pre> 1 Basic Func 2 F Command 3♦Acc.Dec 4 V/F pattern ▼                     </pre>
<b>5</b>	<p>Select a function. Point the cursor to "Acc.Dec" using <b>▼</b>.</p>	<pre> 1 Basic Func 2 F Command 3♦Acc.Dec 4 V/F pattern ▼                     </pre>

<b>6</b>	<p>Press <b>READ</b>.</p> <p>A function list regarding acceleration/deceleration is displayed.</p>	<pre> 1♦Acc1/Dec1 T 2 Acc1/Dec1 P 3 Brake Seq                     </pre>
<b>7</b>	<p>Select a function.</p> <p>Using <b>▲▼</b>, point the cursor to "Acc1/Dec1 T".</p>	<pre> 1♦Acc1/Dec1 T 2 Acc1/Dec1 P 3 Brake Seq                     </pre>
<b>8</b>	<p>Press <b>READ</b>.</p> <p>A parameter list regarding acceleration/deceleration time is displayed.</p>	<pre> 7♦Acc.T1 8 Dec.T1 16 JOG T 20 Acc/DecF                     </pre>
<b>9</b>	<p>When moving the cursor to "Dec.T1" using <b>▲▼</b> and pressing <b>READ</b>, the present set value is called.</p>	<pre> 8 Dec.T1 5.0s ♦ 0~3600                     </pre>

<p><b>10</b></p>	<p>(1) Direct setting Press <b>1</b> <b>8</b> <b>0</b>. *</p> <p>Enter the desired value.</p> <p>Or</p> <p>(2) Step setting Press  .</p> <p>Display "180" using  .</p>	
<p><b>11</b></p>	<p>Press .</p> <p>The set value is changed.</p>	
<p><b>12</b></p>	<p>Press  to display the next parameter.</p>	

\* If  is pressed when an incorrect setting value is input, the display returns to the list display "8".



### 2.3.3 Selecting the parameter from parameter list to change the set value

Example: When changing 5s to 180s at the Pr. 8  
Deceleration time setting

<b>1</b>	<p>Press <b>PU</b>.</p> <p>The frequency setting screen appears, and operation mode changes to PU operation mode.</p>	
<b>2</b>	<p>Press <b>PrSET</b>.</p> <p>The parameter unit is in the parameter setting mode.</p>	
<b>3</b>	<p>Change the screen using <b>▼</b>.</p>	
<b>4</b>	<p>Select a parameter list.</p> <p>Using <b>▲▼</b>, point the cursor to "Pr.List".</p>	
<b>5</b>	<p>Press <b>READ</b>.</p> <p>Select the parameter list.</p> <p>The list of the parameters can be read appears.</p>	







<b>6</b>	<p>Select the parameter.</p> <p>When moving the cursor using <b>▲▼</b> and pressing <b>READ</b> at "Dec.T1", the present set value is called.</p>	
<b>7</b>	<p>(1) Direct setting</p> <p>Press <b>1 8 0</b>. *</p> <p>Enter the desired value.</p> <p>Or</p> <p>(2) Step setting</p> <p>Press <b>▲▼</b>.</p> <p>Display "180" using <b>▲▼</b>.</p>	
<b>8</b>	<p>Press <b>WRITE</b>.</p> <p>The set value is changed.</p>	
<b>9</b>	<p>Press <b>SHIFT</b> to display the next parameter.</p>	



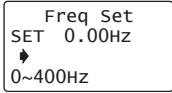
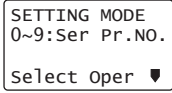

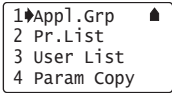

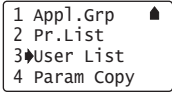

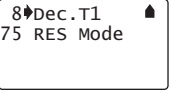
\* If **ESC** is pressed when an incorrect setting value is input, the display returns to the list display "5".

## 2.3.4 Selecting the parameter from User List to change the set value

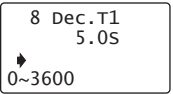
If a parameter is registered to User List, the parameter can be read from User List and changed. (For registering the user group, refer to *page 29*.)

Example: When changing 5s to 180s at the *Pr. 8*  
*Deceleration time* setting

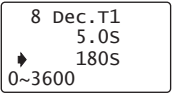
<b>1</b>	<p>Press <b>PU</b>.</p> <p>The frequency setting screen appears, and operation mode changes to PU operation mode.</p>	
<b>2</b>	<p>Press <b>PrSET</b>.</p> <p>The parameter unit is in the parameter setting mode.</p>	
<b>3</b>	<p>Change the screen using .</p>	
<b>4</b>	<p>Select a User List.</p> <p>Using  , point the cursor to "User List".</p>	
<b>5</b>	<p>Press .</p> <p>The list of the parameters registered to User List appears.</p>	

<b>6</b>	<p>Select the parameter.</p> <p>When moving the cursor using   and pressing  at "Dec.T1", the present set value is called.</p>	
<b>7</b>	<p>(1) Direct setting</p> <p>Press <b>1 8 0</b>. *</p> <p>Enter the desired value.</p> <p>Or</p> <p>(2) Step setting</p> <p>Press  .</p> <p>Display "180" using  .</p>	
<b>8</b>	<p>Press <b>WRITE</b>.</p> <p>The set value is changed.</p>	
<b>9</b>	<p>Press <b>SHIFT</b> to display the next parameter.</p>	

\* If **ESC** is pressed when an incorrect setting value is input, the display returns to the list display "5".

### 2.3.5 Precautions for setting write

- Perform parameter setting change during an inverter stop basically in the PU operation mode or combined operation mode. The parameter setting can not be changed in the External operation mode or during inverter operation. (Read is performed independently of the operation mode.) Note that some parameters can be written even in the External operation mode or during operation. Therefore, refer to the inverter manual.
- As *Pr. 77 Parameter write selection* = "0" in the initial setting, parameter can be written only during an inverter stop. (Read is allowed even during operation.) Note that some parameters can be written always. Refer to the inverter manual for details of *Pr. 77*.
- In addition to the above case, setting write cannot be performed when:
  - 1) The parameter number selected does not exist in the parameter list; or
  - 2) The value entered is outside the setting range.
- When write cannot be performed and the "Setting Err." appears, press **(ESC)** and make setting once more. (Example: For *Pr. 7 Acceleration time* )

```
7 Acc.T1
Setting Error
20000S
<ESC>
```

## 2.4 User Group Function

---

- User group function is a function to display only parameters necessary for setting.
- Among all parameters, maximum 16 parameters can be registered to the user group. When "1" is set in *Pr. 160*, only parameters registered in the user group can be accessed for reading and writing. (The parameters not registered to the user group cannot be read.)

### REMARKS

FR-D700 does not have the user group function.

## 2.4.1 Registering the parameters to user group

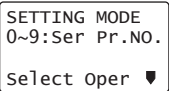
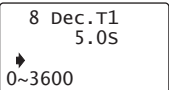
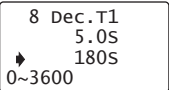
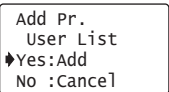
1	<p>Press <b>PrSET</b>.</p> <p>The parameter unit is in the parameter setting mode.</p>	
2	<p>Read the parameters. Enter the parameter number to be registered to the user group with the number keys and press <b>READ</b> to read the parameter setting.</p>	
3	<p>Set the parameters. When changing the set value, enter a new value with the number keys and press <b>WRITE</b> to write. When not changing the setting value, press <b>WRITE</b> to display the setting completion screen.</p>	
4	<p>Press <b>WRITE</b>.</p> <p>The selecting screen appears.</p>	

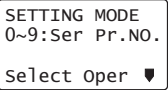
5	<p>Register. When moving the cursor to "YES" and pressing <b>WRITE</b>, the registration is executed.</p>	
6	<p>The parameter setting screen appears. To continue parameter registration, repeat the operation from step 2.</p>	

## 2.4.2 Deleting the parameters from user group

1	<p>Press <b>PrSET</b>.</p> <p>The parameter unit is in the parameter setting mode.</p>	<pre>SETTING MODE 0~9:Ser Pr.NO. Select Oper ▾</pre>
2	<p>Select "User List".</p> <p>Using <b>▲</b>/<b>▼</b>, point the cursor to "3 User List" and press <b>READ</b>.</p>	<pre>1 Appl.Grp ▲ 2 Pr.List 3 User List 4 Param Copy</pre>
3	<p>Select the parameter to be deleted.</p> <p>Using <b>▲</b>/<b>▼</b>, point the cursor to the parameter to be deleted and press <b>WRITE</b>.</p>	<pre>1 Max.F1 2 Min.F1 3 VFbaseF1 7 Acc.T1 ▾</pre>
4	<p>Delete.</p> <p>The screen of delete confirmation appears. When pointing the cursor to "Yes" and pressing <b>WRITE</b>, the parameter is deleted.</p>	<pre>Delete Pr. User List Yes:Delete No :Cancel</pre>

5	<p>To continue deleting parameter, repeat the operation from step 3.</p>	<pre>1 Max.F1 2 Min.F1 7 Acc.T1 8 Dec.T1 ▾</pre>
---	--	--

## 2.4.3 Confirming the parameters registered to user group

1	<p>Press <b>PrSET</b>.</p> <p>The parameter unit is in the parameter setting mode.</p>	<pre>SETTING MODE 0~9:Ser Pr.NO. Select Oper ▾</pre>
2	<p>Select "User List".</p> <p>Using <b>▲</b>/<b>▼</b>, point the cursor to "3 User List" and press <b>READ</b>.</p>	<pre>1 Appl.Grp ▲ 2 Pr.List 3 User List 4 Param Copy</pre>
3	<p>Read the parameter.</p> <p>You can confirm the parameters registered to the user group.</p>	<pre>1 Max.F1 2 Min.F1 3 VFbaseF1 7 Acc.T1 ▾</pre>

### REMARKS

If the parameter is not registered to the user group, "User List Setting Err." will be displayed. Press **ESC** to return to the screen of step 1.

## 2.5 Calibration of the Meter (Frequency Meter)

The functions vary with the inverter. (Refer to the inverter instruction manual for details of the parameters.)

### 2.5.1 Calibration of the FM terminal

#### Parameter

Pr. 900 FM terminal calibration





Pr. 54 FM terminal function selection

Pr. 55 Frequency monitoring reference

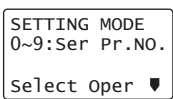
This section provides the way to calibrate the full-scale of meter connected to terminal FM using the parameter unit.

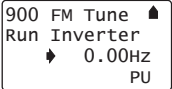
- Calibrating the meter at the running frequency of 60Hz

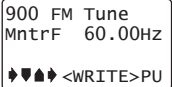
<b>1</b>	<p>Press <b>PU</b>.</p> <p>The frequency setting screen appears, and operation mode changes to PU operation mode.</p>	
<b>2</b>	<p>Press <b>PrSET</b>.</p> <p>The parameter unit is in the parameter setting mode.</p>	

<b>3</b>	<p>Enter <b>9 0 0</b> and press <b>READ</b>.</p> <p>The preset frequency is displayed.</p>	
<b>4</b>	<p>Enter <b>6 0</b> and press <b>WRITE</b>.</p> <p>60Hz is set.</p>	
<b>5</b>	<p>Press <b>FWD</b>.</p> <p>Forward rotation is performed at 60Hz. You need not connect the motor.</p>	
<b>6</b>	<p>Using <b>▲/▼</b>, adjust the meter pointer to a predetermined position. The meter pointer moves. (It takes a long time before the pointer moves.)</p>	

<b>7</b>	Press <b>WRITE</b> . Calibration is complete.	900 FM Tune Completed <MONITOR>
<b>8</b>	Press <b>MON</b> to return to the main monitor screen.	<div style="text-align: right; font-size: small;">READ: List</div> <div style="text-align: center; font-size: large; font-weight: bold;">60.00</div> <div style="text-align: center; font-size: small;">Hz STF FWD PU</div>

## 2.5.2 Calibration of the AM terminal

### Parameter

*Pr. 901 AM terminal calibration*  
*Pr. 158 AM terminal function selection*  
*Pr. 55 Frequency monitoring reference*  
*Pr. 56 Current monitoring reference*

This section provides a way to calibrate the meter connected to terminal AM using the parameter unit.



### (1) Calibration procedure 1

**(Example: To calibrate the meter at the running frequency of 60Hz)**

<b>1</b>	Press <b>PU</b> . The frequency setting screen appears, and operation mode changes to PU operation mode.	<div style="text-align: center;">Freq Set SET 0.00Hz ↓ 0~400Hz</div>
<b>2</b>	Press <b>PrSET</b> . The parameter unit is in the parameter setting mode.	<div style="text-align: center;">SETTING MODE 0~9:Ser Pr.NO.  Select Oper ↓</div>
<b>3</b>	Enter <b>9 0 1</b> and press <b>READ</b> . The preset frequency is displayed.	<div style="text-align: center;">901 AM Tune Run Inverter ↓ 0.00Hz PU</div>

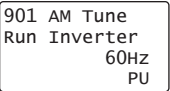
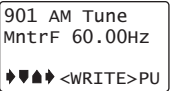
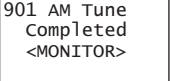

## 7 Calibration of the Meter (Frequency Meter)

4	Enter <b>6</b> <b>0</b> and press <b>WRITE</b> . 60Hz is set.	
5	Press <b>FWD</b> . Forward rotation is performed at 60Hz. You need not connect the motor.	
6	Using <b>▲</b> / <b>▼</b> , adjust the meter pointer to a predetermined position. The meter pointer moves. (It takes a long time before the pointer moves.)	
7	Press <b>WRITE</b> . Calibration is complete.	
8	Press <b>MON</b> to return to the main monitor screen.	

### (2) When calibrating output current

For the output current or another item, which does not easily point 100% value during operation, adjust the reference voltage output, then select the item to be displayed.

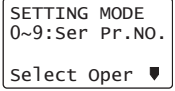
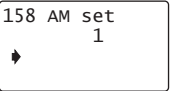
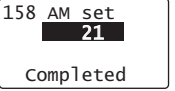
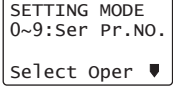
1	Press <b>PU</b> . The frequency setting screen appears, and operation mode changes to PU operation mode.	
2	Press <b>PrSET</b> . The parameter unit is in the parameter setting mode.	
3	Enter <b>1</b> <b>5</b> <b>8</b> and press <b>READ</b> . The present <i>Pr: 158</i> setting appears.	
4	Enter <b>2</b> <b>1</b> and press <b>WRITE</b> . The setting of reference voltage output is complete.	
5	Press <b>PrSET</b> . The parameter unit is in the parameter setting mode.	

<b>6</b>	<p>Enter <b>9</b> <b>0</b> <b>1</b> and press <b>READ</b>.</p> <p>The present <i>Pr. 901</i> setting appears.</p>	<div style="border: 1px solid black; padding: 5px; width: fit-content; margin: auto;">           901 AM Tune            Run Inverter            ◆ 0.00Hz            PU         </div>
<b>7</b>	<p>Enter <b>6</b> <b>0</b> and press <b>WRITE</b>.</p> <p>The setting of maximum running frequency is complete.</p>	<div style="border: 1px solid black; padding: 5px; width: fit-content; margin: auto;">           901 AM Tune            Run Inverter            60Hz            PU         </div>
<b>8</b>	<p>Press <b>FWD</b>.</p> <p>Forward rotation is performed at 60Hz.</p> <p>You need not connect the motor to make adjustment.</p>	<div style="border: 1px solid black; padding: 5px; width: fit-content; margin: auto;">           901 AM Tune            MntrF 1000            ◆◆◆◆&lt;WRITE&gt;PU         </div>
<b>9</b>	<p>Using <b>▲</b>/<b>▼</b>, adjust the voltage across terminals AM-5 and press <b>WRITE</b>.</p> <p>Setting is complete.</p> <p>The output voltage displayed is the value at 100% output. This voltage is not stored if you do not press <b>WRITE</b>.</p>	<div style="border: 1px solid black; padding: 5px; width: fit-content; margin: auto;">           901 AM Tune            Completed            &lt;MONITOR&gt;         </div>

<b>10</b>	<p>Press <b>PrSET</b>.</p> <p>The parameter unit is in the parameter setting mode.</p>	<div style="border: 1px solid black; padding: 5px; width: fit-content; margin: auto;">           SETTING MODE            0~9:Ser Pr.NO.            Select Oper ▼         </div>
<b>11</b>	<p>Enter <b>1</b> <b>5</b> <b>8</b> and press <b>READ</b>.</p> <p>The present <i>Pr. 158</i> setting appears.</p>	<div style="border: 1px solid black; padding: 5px; width: fit-content; margin: auto;">           158 AM set            21            ◆         </div>
<b>12</b>	<p>Enter <b>2</b> and press <b>WRITE</b>.</p> <p>The setting of output current is complete.</p> <p>The output current for 10VDC is the setting value of <i>Pr. 56</i> <i>Current monitoring reference</i> (initial value: rated inverter current).</p>	<div style="border: 1px solid black; padding: 5px; width: fit-content; margin: auto;">           158 AM set  <div style="background-color: black; color: white; padding: 2px; display: inline-block;">2</div>            Completed         </div>

### 2.6 Adjustment of the Frequency Setting Signals "Bias" and "Gain"

The functions vary with the inverter model. (Refer to the inverter instruction manual for details of the functions.)

#### 2.6.1 Adjustment procedure

There are three ways to adjust the bias and gain of the frequency setting voltage (current).

- (1) Adjust only the bias and gain frequencies and not adjust the voltage (current) (*Refer to page 37*)
- (2) Adjust any point by applying a voltage across terminals 2-5 (starting a current across terminals 4-5) (*Refer to page 39*)
- (3) Adjust any point without a voltage being applied across terminals 2-5 (without a current being applied across terminals 4-5) (*Page 41*)

#### Parameter

Pr. 902 Terminal 2 frequency setting bias frequency

Pr. 903 Terminal 2 frequency setting gain

Pr. 904 Terminal 4 frequency setting bias frequency

Pr. 905 Terminal 4 frequency setting gain

## Adjustment of the Frequency Setting Signals "Bias" and "Gain"

- (1) Adjust only the bias and gain frequencies and not adjust the voltage
- Setting of the frequency setting voltage bias

<b>1</b>	<p>Press <b>PU</b>.</p> <p>The frequency setting screen appears, and operation mode changes to PU operation mode.</p>	<pre style="font-family: monospace;"> Freq Set SET 0.00Hz   ↓ 0~400Hz                     </pre>
<b>2</b>	<p>Press <b>PrSET</b>.</p> <p>The parameter unit is in the parameter setting mode.</p>	<pre style="font-family: monospace;"> SETTING MODE 0~9:Ser Pr.NO. Select Oper ▼                     </pre>
<b>3</b>	<p>Enter <b>9 0 2</b> and press <b>READ</b>.</p> <p>The present Pr. 902 setting appears.</p>	<pre style="font-family: monospace;"> 902 Ext2bias   ↓   0.00Hz Set&lt;WRITE&gt; Ext&lt;READ&gt;                     </pre>
<b>4</b>	<p>Enter <b>1 0</b>.</p> <p>Voltage need not be applied across terminals 2-5.</p>	<pre style="font-family: monospace;"> 902 Ext2bias   ↓   10Hz Set&lt;WRITE&gt;                     </pre>

<p><b>5</b> Press <b>WRITE</b>.</p> <p>The bias frequency is set at 10Hz.</p> <div style="text-align: center;"> </div> <p>If the voltage is being applied across terminals 2- 5 at this time, the bias setting is as shown above.</p>	<div style="border: 1px solid black; padding: 5px; margin-bottom: 10px;"> <pre style="font-family: monospace;"> 902 Ext2bias   ↓   10.00Hz                     </pre> </div> <p style="text-align: center;">Completed</p>
---	---

## 7 Adjustment of the Frequency Setting Signals "Bias" and "Gain"

- Setting of the frequency setting voltage gain

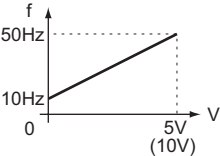
6	Press <b>SHIFT</b> . The present setting appears.	<pre>903 Ext2gain   * 60.00Hz Set&lt;WRITE&gt; Ext&lt;READ&gt;</pre>
7	Enter <b>5 0</b> . Voltage need not be applied across terminals 2-5.	<pre>903 Ext2gain   * 50Hz Set&lt;WRITE&gt;</pre>
8	Press <b>WRITE</b> . The bias frequency is set at 50Hz. At this time, set the gain on the assumption that the 5V (10V) in the inverter is the set voltage. 	<pre>903 Ext2gain   * <b>50.00Hz</b> Completed</pre>

The adjustment of the frequency setting voltage bias and gain is complete.

### REMARKS

- 1 The current input (*Pr. 904*) can also be adjusted using a similar procedure.
- 2 The *Pr. 903 Terminal 2 frequency setting gain* remains unchanged if the *Pr. 20 Acceleration/deceleration reference frequency* setting is changed.

## Adjustment of the Frequency Setting Signals "Bias" and "Gain"

(2) Adjust any point by application of voltage to across terminals 2-5

• Setting of the frequency setting voltage bias

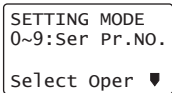
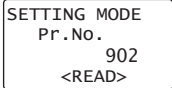
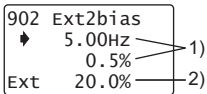
<b>1</b>	<p>Press <b>PU</b>.</p> <p>The frequency setting screen appears, and operation mode changes to PU operation mode.</p>	
<b>2</b>	<p>Press <b>PrSET</b>.</p> <p>The parameter unit is in the parameter setting mode.</p>	
<b>3</b>	<p>Enter <b>9 0 2</b>.</p>	
<b>4</b>	<p>Press <b>READ</b> twice.</p> <p>The present <i>Pr. 902</i> setting appears.</p> <p>When the set voltage is changed, the % value also changes.</p> <p>This example assumes that a 1V voltage is applied.</p> <p>The value selected in <i>Pr. 73</i> (5V in this example) is 100%.</p>	 <p>1) The previous setting is displayed.</p> <p>2) The present set voltage across terminals 2-5 is displayed in %.</p>

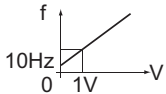
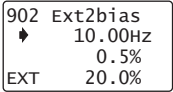
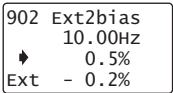
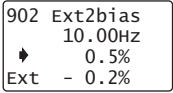
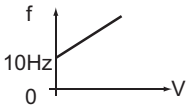
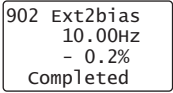
<b>5</b>	<p>Enter <b>1 0</b>.</p> <p>Set the bias frequency at 10Hz.</p> 	
<b>6</b>	<p>Press <b>WRITE</b>.</p> <p>The cursor (▶) moves to the set voltage.</p>	
<b>7</b>	<p>Apply a 0V voltage.</p> <p>In this example, 0V is applied as 10Hz is set for 0V.</p> <p>(Indicated % on the right changes.)</p>	
<b>8</b>	<p>Press <b>WRITE</b>.</p> <p>The bias frequency is set at 10Hz for 0V input.</p> <p>Setting is completed as shown below:</p> 	 <p>0.0% of analog input value may not be displayed in some cases.</p>

## 7 Adjustment of the Frequency Setting Signals "Bias" and "Gain"

### • Setting of the frequency setting voltage gain

<p><b>9</b></p>	<p>Press <b>SHIFT</b>, then <b>READ</b>.</p> <p>The present <i>Pr. 903</i> setting appears.</p> <p>When the set voltage is changed, the % value also changes.</p> <p>The value selected in <i>Pr. 73</i> (5V in this example) is 100%.</p>	<pre>903 Ext2gain   60.00Hz 1)   97.1% Ext 80.0% 2)</pre> <p>1) The previous setting is displayed.</p> <p>2) The present set voltage across terminals 2-5 is displayed in %.</p>
<p><b>10</b></p>	<p>Enter <b>5</b> <b>0</b>.</p>	<pre>903 Ext2gain   50Hz   97.1% Ext 80.0%</pre>
<p><b>11</b></p>	<p>Press <b>WRITE</b>.</p> <p>The cursor (▶) moves to the set voltage.</p>	<pre>903 Ext2gain   50.00Hz   97.1% Ext 80.0%</pre>
<p><b>12</b></p>	<p>Apply a 5V voltage.</p> <p>In this example, 5V is applied to set 50Hz for 5V input.</p>	<pre>903 Ext2gain   50.00Hz   97.1% Ext 80.0%</pre>

**13**

Press **WRITE**.

The gain frequency is set at 50Hz for 5V input. Setting is completed as shown below:

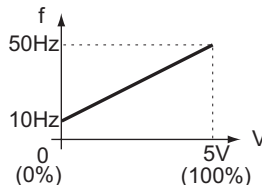

```
903 Ext2gain
  50.00Hz
  99.6%
Completed
```

The value displayed may not be just 100.0% in some cases.

The adjustment of the frequency setting voltage bias and gain is complete.

### REMARKS

- 1 The current input (*Pr. 904*, *Pr. 905*) can also be adjusted using a similar procedure.
- 2 The *Pr. 903 Terminal 2 frequency setting gain* remains unchanged even if the *Pr. 20 Acceleration/ deceleration reference frequency* setting is changed.
- 3 A narrow calibration (command) value set using *Pr. 902* and *Pr. 903* (*Pr. 904* and *Pr. 905*) will result in "Incr I/P" and disable write.

## Adjustment of the Frequency Setting Signals "Bias" and "Gain"

(3) Adjust any point without application of voltage to across terminals 2-5

• Setting of the frequency setting voltage bias

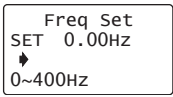
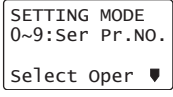
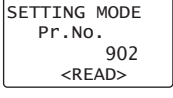
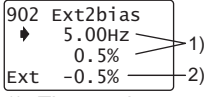
<b>1</b>	<p>Press <b>PU</b>.</p> <p>The frequency setting screen appears, and operation mode changes to PU operation mode.</p>	
<b>2</b>	<p>Press <b>PrSET</b>.</p> <p>The parameter unit is in the parameter setting mode.</p>	
<b>3</b>	<p>Enter <b>9 0 2</b>.</p>	
<b>4</b>	<p>Press <b>READ</b> twice.</p> <p>The present <i>Pr. 902</i> setting appears.</p> <p>When the set voltage is changed, the % value also changes.</p> <p>The value selected in <i>Pr. 73</i> (5V in this example) is 100%.</p>	 <p>1) The previous setting is displayed.</p> <p>2) The present set voltage across terminals 2-5 is displayed in %.</p>

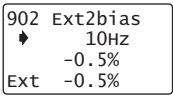
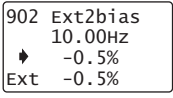
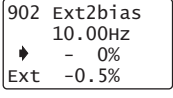
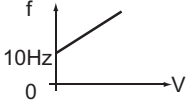
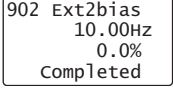
<b>5</b>	<p>Enter <b>1 0</b>.</p> <p>Set the bias frequency at 10Hz.</p>	
<b>6</b>	<p>Press <b>WRITE</b>.</p> <p>The cursor (➡) moves to the set voltage.</p> <p>Voltage need not be applied across terminals 2-5.</p>	
<b>7</b>	<p>Enter <b>0</b>.</p> <p>Input 0V to set bias.</p>	
<b>8</b>	<p>Press <b>WRITE</b>.</p> <p>The bias frequency is set at 10Hz.</p> <p>Setting is completed as shown below:</p> 	



## 7 Adjustment of the Frequency Setting Signals "Bias" and "Gain"

### • Setting of the frequency setting voltage gain

9	<p>Press <b>SHIFT</b>, then <b>READ</b>.</p> <p>The present <i>Pr. 903</i> setting value appears.</p> <p>When the set voltage is changed, the % value also changes.</p> <p>The value selected in <i>Pr. 73</i> (5V in this example) is 100%.</p>	<pre>903 Ext2gain   60.00Hz   97.1% Ext 80.0%</pre> <p>1) The previous setting is displayed.</p> <p>2) The present set voltage across terminals 2-5 is displayed in %.</p>
10	<p>Enter <b>5 0</b>.</p> <p>Set the gain frequency at 50Hz.</p>	<pre>903 Ext2gain   50Hz   97.1% Ext 80.0%</pre>
11	<p>Press <b>WRITE</b>.</p> <p>The cursor (➡) moves to the set voltage.</p> <p>Voltage need not be applied across terminals 2-5.</p>	<pre>903 Ext2gain   50.00Hz   97.1% Ext 80.0%</pre>
12	<p>Enter <b>1 0 0</b>.</p> <p>Input 5V to set gain.</p>	<pre>903 Ext2gain   50.00Hz   100.0% Ext 80.0%</pre>

13

Press **WRITE**.

The gain frequency is set at 50Hz.

Setting is completed as shown below:

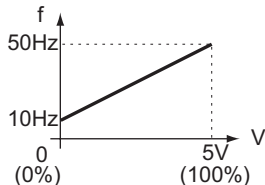

```
903 Ext2gain
  50.00Hz
  100.0%
Completed
```

The adjustment of the frequency setting voltage bias and gain is complete.

### REMARKS

- 1 The current input (*Pr. 904*, *Pr. 905*) can also be adjusted using a similar procedure.
- 2 The *Pr. 903 Terminal 2 frequency setting gain* remains unchanged even if the *Pr. 20 Acceleration/ deceleration reference frequency* setting is changed.
- 3 A narrow calibration (command) value set using *Pr. 902* and *Pr. 903* (*Pr. 904* and *Pr. 905*) will result in "Incr I/P" and disable write.

# 3 FUNCTION MENU

## 3.1 Overview of Function Menu

Press **(FUNC)** in any operation mode to call the function menu, on which you can perform various functions.

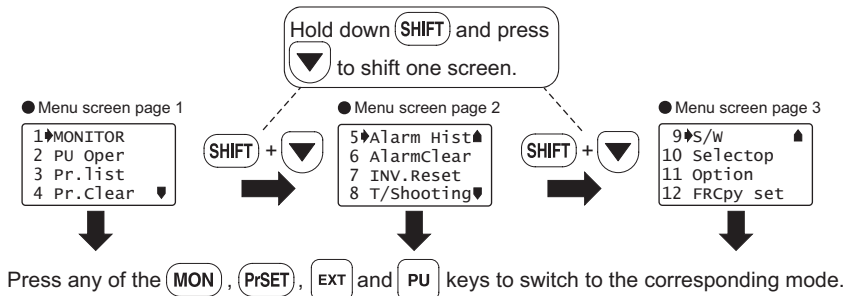

### 3.1.1 Function menu

Function Menu	Description	Refer To Page
1. MONITOR	The monitor list appears, and you can change from one monitor to another and set the first priority monitor.	49
2. PU Oper	You can select the PU operation mode via direct input (direct setting with the number keys) or select the Jog operation mode from the PU, and displays how to operate the keys.	50
3. Pr.List	The parameter menu appears, and you can perform "parameter setting", "list display", "parameter change list display" and "initial value list display".	52
4. Pr.Clear	The parameter clear menu appears, and you can perform "parameter clear" and "all clear".	55

Function Menu	Description	Refer To Page
5. Alarm Hist	This function displays history of past eight faults (alarms).	57
6. AlarmClear	This function clears all the fault (alarm) history.	58
7. Inv.Reset	This function resets the inverter.	59
8. T/Shooting	The inverter displays the cause of mismatch between inverter operation and control/setting or the cause of an inverter fault.	59
9. S/W	This function displays the software control number of the inverter.	-
10. Selectop	This function displays the signals assigned to the I/O terminals of the control circuit and the ON/OFF states of the signals.	64
11. Option	This function displays the option fitting states of the option connectors 1 to 3.	65
12. FRCpy set	The function can perform the "parameter copy" (read, write, verification).	66

### REMARKS

The functions vary with the inverter model and may be invalid for some inverters.

### 3.1.2 Function menu transition

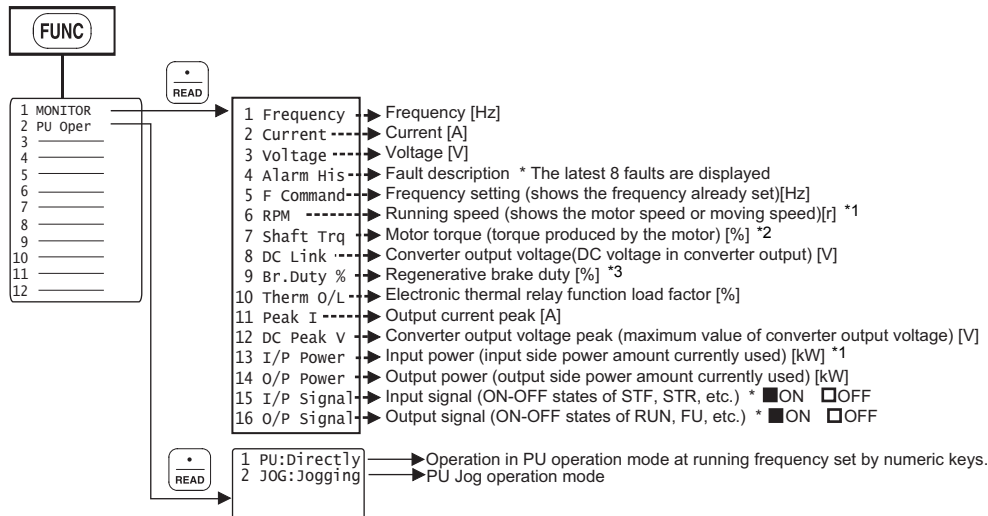

- \*1 Cannot be monitored for the FR-E700 and FR-D700 series.
- \*2 Cannot be monitored for the FR-F700 and FR-D700 series.
- \*3 Can be monitored for the FR-F700 series with the 75K or higher.

# 7 Overview of Function Menu

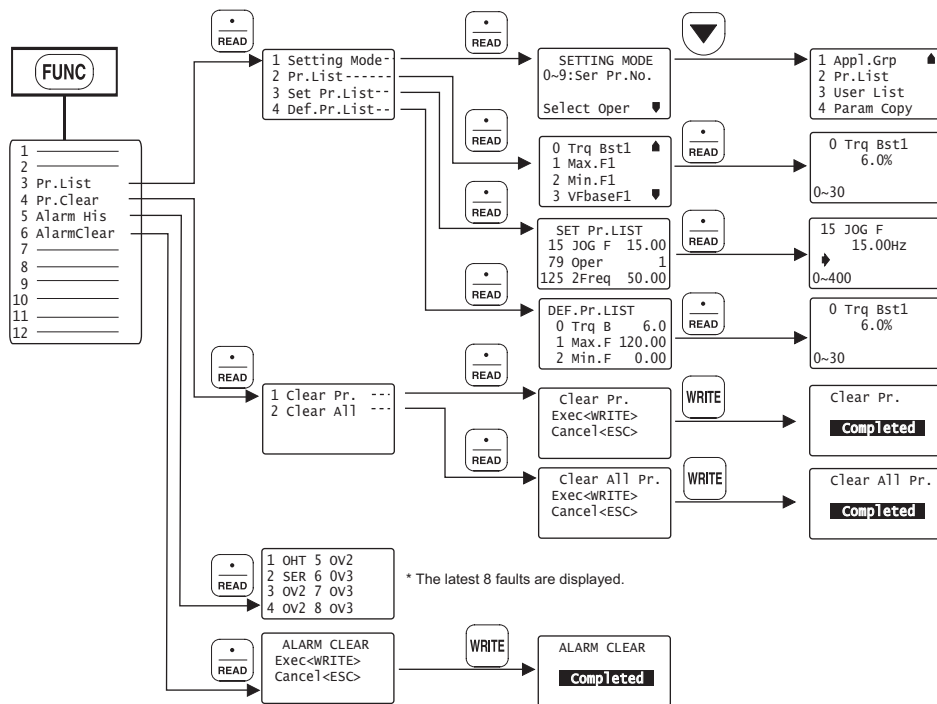

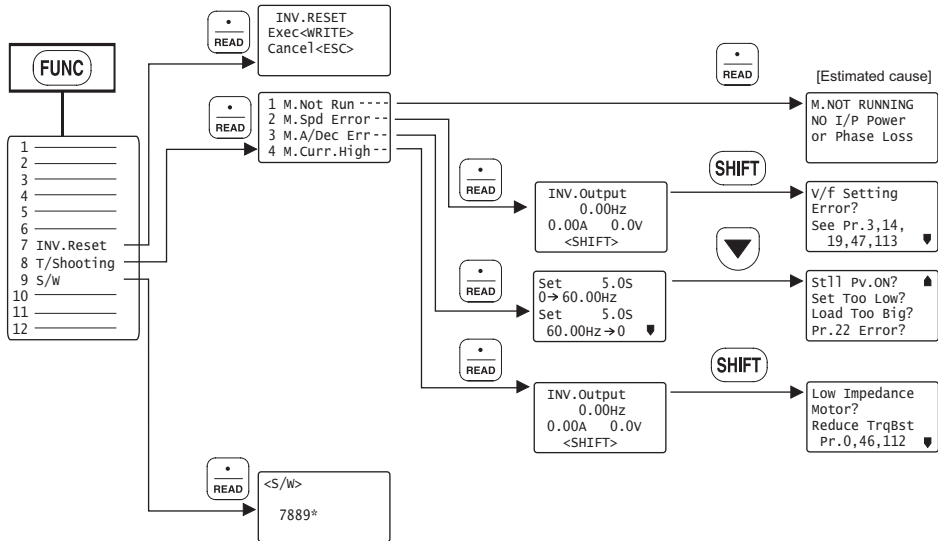



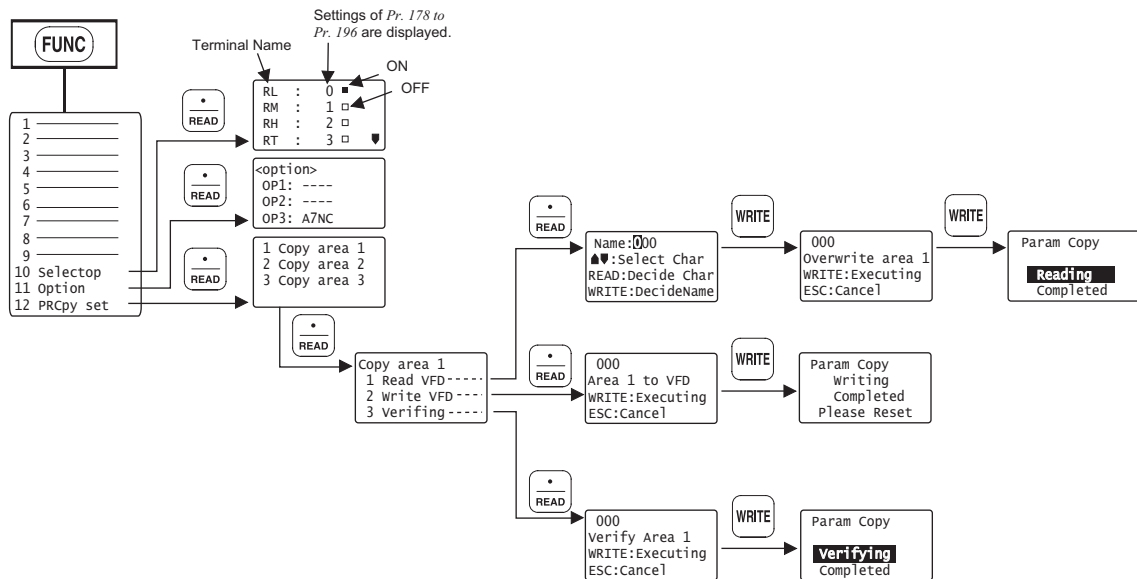





# 7 Overview of Function Menu



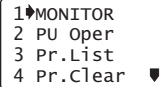

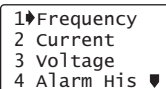
## 3.2 Operation Procedures for Functions

### 3.2.1 Monitor function

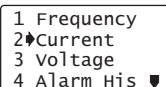
The monitoring list appears and you can change from one monitor screen to another and set the first priority screen.

<b>1</b>	Press <b>FUNC</b> . The function menu is called.	
<b>2</b>	Make sure that the cursor is located at "1 MONITOR". If not, move the cursor with  /  .	
<b>3</b>	Press  . The monitoring list is called.	
<b>4</b>	Press  or  to move the cursor to the desired item. Hold down <b>SHIFT</b> and press  /  to shift one screen.	

<b>5</b>	Press  . The monitor screen selected by the cursor appears. Press <b>WRITE</b> to give the first priority to this monitor screen.	
----------	--	---

#### REMARKS

- The monitoring list can be called only with pressing  in the monitoring mode. (Refer to page 17)
- "4 Alarm His" can not be set to the first priority monitor.
- Some monitoring items are not displayed depending on the connected inverter. To check the available monitoring items, refer to the setting range of Pr:52 DU/PU main display data selection of the inverter.



## 3.2.2 Selection of PU operation (direct input)

You can select the PU operation mode to set PU operation frequency.

1	<p>Press <b>FUNC</b>.</p> <p>The function menu is called.</p>	<pre> 1 MONITOR 2 PU Oper 3 Pr.List 4 Pr.Clear           </pre>
2	<p>Using <b>▼</b>, move the cursor to "2 PU Oper".</p>	<pre> 1 MONITOR 2 PU Oper 3 Pr.List 4 Pr.Clear           </pre>
3	<p>Press <b>READ</b>.</p> <p>The menu on the right appears.</p>	
4	<p>Make sure that the cursor is located at "1 PU: Directly".</p> <p>If not, move the cursor with <b>▲/▼</b>.</p>	<pre> 1 PU:Directly 2 JOG:Jogging           </pre>
5	<p>Press <b>READ</b>.</p> <p>The PU operation mode is selected and the frequency setting screen appears.</p>	<pre> Freq Set SET 0.00Hz   ↓ 0~400Hz           </pre>

6	<p>Enter the set frequency using <b>0</b> to <b>9</b> and press <b>WRITE</b>.</p> <p>The frequency setting is complete.</p>	<pre> Freq Set SET 60.00Hz Completed           </pre>
7	<p>Press <b>FWD/REV</b> to perform forward or reverse rotation with the set frequency.</p>	<pre> READ:List 60.00 Hz STF FWD PU           </pre>



### REMARKS

- Press **PU** to call the frequency setting screen any time.

### 3.2.3 Selection of the PU Jog operation mode

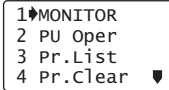
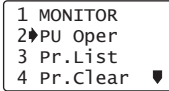
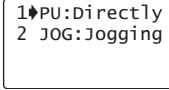
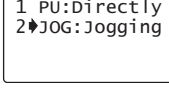
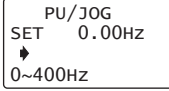
You can select the PU Jog operation mode to set PU jog frequency.

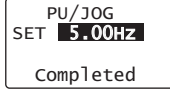
1	Press <b>FUNC</b> . The function menu is called.	
2	Using <b>▼</b> , move the cursor to "2 PU Oper".	
3	Press <b>READ</b> . The menu on the right appears.	
4	Using <b>▼</b> , move the cursor to "2 JOG: Jogging".	
5	Press <b>READ</b> . The PU Jog operation mode is selected, and the frequency setting screen appears.	

6	Enter the set frequency using <b>0</b> to <b>9</b> and press <b>WRITE</b> . The PU Jog frequency setting is complete.	
7	Hold down <b>FWD</b> / <b>REV</b> to perform forward or reverse rotation with the PU Jog set frequency.	

#### REMARKS

- Press **SHIFT** to call the PU Jog frequency setting screen any time after pressing **PU**.

### **3.2.4 Parameters**

When selecting the parameter on the function menu, the parameter menu is displayed, and you can perform the following operations for the parameters.

	<b>Display</b>	<b>Description</b>
<b>1</b>	Setting Mode	Switches to the parameter setting mode to read and write the parameter setting.
<b>2</b>	Pr. List	Displays the parameters list. You can select the parameter from the list to read and write the parameter setting.
<b>3</b>	Set Pr. List	Lists the parameters whose setting is changed from initial value. You can select the parameter from the list to read and write the parameter setting.
<b>4</b>	Def.Pr. List	Displays the parameters and initial value list. You can select the parameter from the list to read and write the parameter setting.

**(1) "1 Setting Mode"**

<b>1</b>	Press <b>(FUNC)</b> . The function menu is called.	<div style="border: 1px solid black; padding: 5px;">                 1 MONITOR                  2 PU Oper                  3 Pr.List                  4 Pr.Clear ▾             </div>
<b>2</b>	Using <b>(▼)</b> , move the cursor to "3 Pr. List".	<div style="border: 1px solid black; padding: 5px;">                 1 MONITOR                  2 PU Oper                  3 Pr.List                  4 Pr.Clear ▾             </div>
<b>3</b>	Press <b>(READ)</b> . The parameter menu appears.	<div style="border: 1px solid black; padding: 5px;">                 1 Setting Mode                  2 Pr.List                  3 Set Pr.List                  4 Def.Pr.List             </div>
<b>4</b>	Press <b>(READ)</b> . The parameter unit switches to the setting mode. Refer to <i>page 23</i> to set the parameters.	<div style="border: 1px solid black; padding: 5px;">                 SETTING MODE                  0~9:Ser Pr.NO.                  Select Oper ▾             </div>





**(2) "2 Pr.List"**

<b>1</b>	Call the parameter menu similarly to above steps 1 to 3.	<div style="border: 1px solid black; padding: 5px;">                 1 Setting Mode                  2 Pr.List                  3 Set Pr.List                  4 Def.Pr.List             </div>
----------	--	---

<b>2</b>	Using <b>(▼)</b> , move the cursor to "2 Pr. List".	<div style="border: 1px solid black; padding: 5px;">                 1 Setting Mode                  2 Pr.List                  3 Set Pr.List                  4 Def.Pr.List             </div>
<b>3</b>	Press <b>(READ)</b> . The parameter menu appears.	
<b>4</b>	Press <b>(▲)</b> / <b>(▼)</b> to move the cursor to the desired parameter.  Press <b>(SHIFT)</b> and <b>(▼)</b> together to shift to the next page.	<div style="border: 1px solid black; padding: 5px;">                 0 Trq Bst1 ▲                  1 Max.F1                  2 Min.F1                  3 VfbaseF1 ▾             </div>
<b>5</b>	Press <b>(READ)</b> . The parameter indicated by the cursor is read, and the parameter unit is in the parameter setting mode. Refer to <i>page 23</i> to set the parameters.	<div style="border: 1px solid black; padding: 5px;">                 0 Trq Bst1                  6.0%                  0~30                  ▼             </div>





 Press **(SHIFT)** to move to the next parameter.

## (3) Display of "3 Set Pr.List"

1	Call the parameter menu similarly to steps 1 to 3 of <i>page 53</i> .	<pre> 1▶Setting Mode 2 Pr.List 3 Set Pr.List 4 Def.Pr.List                     </pre>
2	Using  /  , move the cursor to "3 Set Pr. List".	<pre> 1 Setting Mode 2 Pr.List 3▶Set Pr.List 4 Def.Pr.List                     </pre>
3	Press  . The change list appears. When the parameter has been changed from the initial value, the new value is displayed.	<pre> SET Pr.LIST 1▶Max.F1  0.00 18 Max.F2  0.00 125 2Freq  50.00                     </pre>
4	Press  . The parameter indicated by the cursor is read, and the parameter unit is in the parameter setting mode. Refer to <i>page 23</i> to set the parameters.	<pre> 1 Max.F1   0.00Hz ▶ 0~120                     </pre>

## (4) Display of "4 Def.Pr.List"

The initial values of parameters are displayed.

1	Call the parameter menu similarly to steps 1 to 3 of <i>page 53</i> .	<pre> 1▶Setting Mode 2 Pr.List 3 Set Pr.List 4 Def.Pr.List                     </pre>
2	Using  /  , move the cursor to "4 Def. Pr. List".	<pre> 1 Setting Mode 2 Pr.List 3 Set Pr.List 4▶Def.Pr.List                     </pre>
3	Press  . The initial value list appears.	<pre> DEF.Pr.LIST 0▶Trq B    6.0 1 Max.F    120.00 2 Min.F    0.00                     </pre>
4	Press  . The parameter indicated by the cursor is read, and the parameter unit is in the parameter setting mode. Refer to <i>page 23</i> to set the parameters.	<pre> 0 Trq Bst1   6.0% ▶ 0~30                     </pre>







### 3.2.5 Parameter clear

You can perform the "parameter clear" and "all parameter clear".

Switch to the PU operation mode before performing any operation.







- Clear Pr. .... Returns (initializes) the parameters to the factory settings with the exception of the some parameters (*Pr. 75* and calibration values in *Pr. 900 to Pr. 905* ).
- Clear All..... Initializes all parameters with the exception of *Pr. 75*.

#### (1) Parameter clear

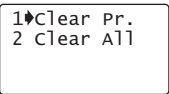
<b>1</b>	Press <b>FUNC</b> . The function menu is called.	<div style="border: 1px solid black; padding: 5px;">                     1 MONITOR                      2 PU Oper                      3 Pr.List                      4 Pr.Clear                 </div>
<b>2</b>	Using  /  , move the cursor to "4 Pr. Clear".	<div style="border: 1px solid black; padding: 5px;">                     1 MONITOR                      2 PU Oper                      3 Pr.List                      4 Pr.Clear                 </div>
<b>3</b>	Press  . The parameter menu appears.	<div style="border: 1px solid black; padding: 5px;">                     1 Clear Pr.                      2 Clear All                 </div>
<b>4</b>	Select the "Clear Pr." Using  /  , move the cursor to "1" and press the  .	<div style="border: 1px solid black; padding: 5px;">                     1 Clear Pr.                      2 Clear All                 </div>



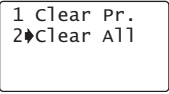
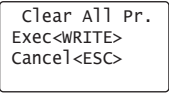

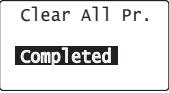

<b>5</b>	"Clear Pr." is selected, and the confirmation screen for clearing execution is displayed.	<div style="border: 1px solid black; padding: 10px;">                     Clear Pr.                      Exec&lt;WRITE&gt;                      Cancel&lt;ESC&gt;                 </div>
<b>6</b>	Press  . The parameters are initialized. When canceling the initialization, press <b>ESC</b> on the confirmation screen.	<div style="border: 1px solid black; padding: 10px;">                     Clear Pr.  <span style="background-color: black; color: white; padding: 2px 5px;"><b>Completed</b></span> </div>

## (2) All parameter clear

1	Call the parameter menu similarly to steps 1 to 3 of <i>page 55</i> .	
2	Select the "Clear All". Using  /  , move the cursor to "2 Clear All" and press the  .	
3	"Clear All" is selected, and the confirmation screen for clearing execution is displayed.	
4	Press  . The parameters are initialized. When canceling the initialization, press  on the confirmation screen.	

### 3.2.6 Alarm history

Shows the history of past eight faults.

<b>1</b>	<p>Press <b>(FUNC)</b>.</p> <p>The function menu is called.</p>	<div style="border: 1px solid black; padding: 5px;"> <p>1▶MONITOR 2 PU Oper 3 Pr.List 4 Pr.Clear ▼</p> </div>
<b>2</b>	<p>Using /, move the cursor to "5 Alarm His".</p> <p>Hold down <b>(SHIFT)</b> and press / to shift one screen.</p>	<div style="border: 1px solid black; padding: 5px;"> <p>5▶Alarm His ▲ 6 AlarmClear 7 INV.Reset 8 T/Shooting ▼</p> </div>
<b>3</b>	<p>Press .</p> <p>The fault history appears.</p>	<div style="border: 1px solid black; padding: 5px;"> <p>1 OHT 5 OV2 2 SER 6 OV3 3 OV2 7 OV3 4 OV2 8 OV3</p> </div>
<b>4</b>	<p>Press .</p> <p>The running frequency at fault occurrence is displayed.</p>	<div style="border: 1px solid black; padding: 5px;"> <p>LATEST ERR</p> <p>OH Fault 0.00Hz ▼</p> </div>
<b>5</b>	<p>Press .</p> <p>The output current, output voltage and cumulative energization time at fault occurrence is displayed.</p>	<div style="border: 1px solid black; padding: 5px;"> <p>LATEST ERR ▲</p> <p>0.00A 0.0V 7hr</p> </div>

<b>6</b>	<p>Press  when displaying the operation mode for fault occurrence in steps 4 and 5 to display the operation data for the preceding fault occurrence.</p>	<div style="border: 1px solid black; padding: 5px;"> <p>2nd Prev.ERR ▲</p> <p>PU Leave Out 0.00Hz</p> </div>
----------	---	--



## 3.2.7 Alarm clear

Clears all the fault history.

1	<p>Press <b>FUNC</b>.</p> <p>The function menu is called.</p>	<div style="border: 1px solid black; padding: 5px;"> <p>1 MONITOR</p> <p>2 PU Oper</p> <p>3 Pr.List</p> <p>4 Pr.Clear ▾</p> </div>
2	<p>Using <b>▲</b>/<b>▼</b>, move the cursor to "6 AlarmClear".</p> <p>Hold down <b>SHIFT</b> and press <b>▲</b>/<b>▼</b> to shift one screen.</p>	<div style="border: 1px solid black; padding: 5px;"> <p>5 Alarm His ▲</p> <p>6 AlarmClear</p> <p>7 INV.Reset</p> <p>8 T/Shooting ▾</p> </div>
3	<p>Press <b>READ</b>.</p> <p>"AlarmClear" is selected, and the confirmation screen for clearing is displayed.</p>	<div style="border: 1px solid black; padding: 5px;"> <p>ALARM CLEAR</p> <p>Exec&lt;WRITE&gt;</p> <p>Cancel&lt;ESC&gt;</p> </div>
4	<p>Press <b>WRITE</b>.</p> <p>The fault history is cleared. When canceling the clear, press <b>ESC</b> on the confirmation screen.</p>	<div style="border: 1px solid black; padding: 5px;"> <p>ALARM CLEAR</p> <p><b>Completed</b></p> </div>

### 3.2.8 Inverter reset

Resets the inverter.

1	Press <b>FUNC</b> . The function menu is called.	<div style="border: 1px solid black; padding: 5px;">                     1 MONITOR                      2 PU Oper                      3 Pr.List                      4 Pr.Clear ▾                 </div>
2	Using <b>▲</b> / <b>▼</b> , move the cursor to "7 INV. Reset".  Hold down <b>SHIFT</b> and press <b>▲</b> / <b>▼</b> to shift one screen.	<div style="border: 1px solid black; padding: 5px;">                     5 Alarm His ▲                      6 AlarmClear                      7 INV.Reset                      8 T/Shooting ▾                 </div>
3	Press <b>READ</b> . "INV. Reset" is selected, and the confirmation screen for reset is displayed.	<div style="border: 1px solid black; padding: 5px;">                     INV.RESET                      Exec&lt;WRITE&gt;                      Cancel&lt;ESC&gt;                 </div>
4	Press <b>WRITE</b> . The inverter is reset, and the parameter unit switches to the monitoring mode. When canceling the inverter reset, press <b>ESC</b> on the confirmation screen.	<div style="border: 1px solid black; padding: 10px; text-align: center;">                     READ:List  <span style="font-size: 2em;">0.00</span> Hz                      --- STOP EXT                 </div>

#### REMARKS

- If the inverter's protective function is activated to bring the inverter to trip (output shutoff), execute the inverter reset only by pressing **STOP RESET**.
- A similar reset operation may also be performed by switching power ON again or by switching the RES signal ON. (Refer to the inverter instruction manual for details.)

## 3.2.9 Troubleshooting

If the inverter appears to operate improperly, perform the following operation to display the most likely cause of the fault.

This operation may also be performed during inverter operation (PU operation, External operation) or during trip (protection activated).

<b>1</b>	<p>Press <b>FUNC</b>.</p> <p>The function menu is called.</p>	<div style="border: 1px solid black; padding: 5px;"> <p>1♦MONITOR 2 PU Oper 3 Pr.List 4 Pr.Clear ▾</p> </div>
<b>2</b>	<p>Using <b>▲</b>/<b>▼</b>, move the cursor to "8 T/Shooting".</p> <p>Hold down <b>SHIFT</b> and press <b>▲</b>/<b>▼</b> to shift one screen.</p>	<div style="border: 1px solid black; padding: 5px;"> <p>5 Alarm His ▲ 6 AlarmClear 7 INV.Reset 8♦T/Shooting ▾</p> </div>
<b>3</b>	<p>Press <b>READ</b>.</p> <p>The fault menu appears.</p>	<div style="border: 1px solid black; padding: 5px;"> <p>1♦M.Not Run 2 M.Spd Error 3 M.A/Dec Err 4 M.Curr.High</p> </div>
<b>4</b>	<p>Press <b>▲</b> or <b>▼</b> to move the cursor to the desired item.</p>	<div style="border: 1px solid black; padding: 5px;"> <p>1 M.Not Run 2♦M.Spd Error 3 M.A/Dec Err 4 M.Curr.High</p> </div>

<b>5</b>	<p>Press <b>READ</b>.</p> <p>The estimated cause of the fault is displayed. (Refer to page 61)</p>	<div style="border: 1px solid black; padding: 5px;"> <p>M.SPEED ERROR SetF&gt;Max.F1/F2 60.00Hz Pr.1/18</p> </div>
----------	--	--

## Troubleshooting guidance

### 1) M.NOT RUNNING (Motor does not run)

M.NOT RUNNING  
ALARM  
Indicated  
<SHIFT>

The protective function is activated to bring the inverter to trip.  
Press **(SHIFT)** to display the cause of the trip.

M.NOT RUNNING  
Max. Fl<StartF  
Pr. 1 Pr. 13

The inverter cannot start because the inverter starting frequency (*Pr. 13*) is higher than the maximum frequency (*Pr. 1*).

M.NOT RUNNING  
NO I/P Power  
or Phase Loss

The inverter's main circuit power has decreased or a phase in the power supply is lost. Check the power supply.

M.NOT RUNNING  
EnableFR Set  
See Pr. 78

The inverter cannot start because you attempted to run the motor in the direction in which forward or reverse rotation is inhibited as set in *Pr. 78*.

M.NOT RUNNING  
STF, STR  
both are OFF  
or ON

Both start signals STF and STR are ON or OFF.

M.NOT RUNNING  
Current Limit  
Activated  
<SHIFT>

The inverter cannot start since the current limit function is activated. Press **(SHIFT)** to display the estimated cause that the current limit function was activated.

M.NOT RUNNING  
MRS is ON

MRS signal is ON.

M.NOT RUNNING  
Under  
PID Control

The inverter does not start because the inverter need not start the motor as a result of the arithmetic operation of PID control.

M.NOT RUNNING  
SetF<StartF  
Pr. 13

The inverter starting frequency (*Pr. 13*) setting is higher than the frequency currently set.

M.NOT RUNNING  
CS is OFF  
See Pr. 57

The inverter will not restart since the automatic restart after instantaneous power failure select signal CS is OFF. It is estimated that an instantaneous power failure has occurred or the inverter in the commercial power supply switch-over operation mode.

M.NOT RUNNING  
AU is OFF

The current input select signal AU remains OFF. (not ON)

M.NOT RUNNING  
NO Command  
From PU

Neither of **(FWD)** and **(REV)** are pressed in the PU operation mode.

## 2) M.SPEED ERROR

(Speed does not match the running frequency setting)

M. SPEED ERROR  
SetF>MaxF1/F2  
60.00 Hz  
Pr.1/18

Since the running frequency setting is higher than the maximum frequency (Pr. 1) setting, the running frequency remains at the maximum frequency.

M. SPEED ERROR  
SetF<MinF1  
60.00Hz  
Pr.2

Since the running frequency setting is lower than the minimum frequency (Pr. 2) setting, the running frequency has been increased to the minimum frequency.

M. SPEED ERROR  
Fjump Working  
See Pr. 31-36  
SetF= 60.00Hz

Since the running frequency setting is within the frequency jump setting range (Pr. 31 to 36), the running frequency has jumped.

M. SPEED ERROR  
Current Limit  
Activated  
<SHIFT>

The current limit function was activated and forced the running frequency to reduce. Press (SHIFT) to display the cause that the current limit function was activated.

M. SPEED ERROR  
Under  
PI-Control

As a result of arithmetic operation of PID control, the running frequency differs from the set value.

## 3) M.A/Dec Err

(Actual acceleration/deceleration time is longer than the Pr. 7/Pr. 8 setting)

Set 5.0s  
0 60.00Hz  
Set 5.0s  
60.00Hz 0

Acceleration time setting (Pr. 7) is displayed.

Frequency reached in the above set time (Pr. 20 Acceleration/deceleration reference frequency) is displayed.

Deceleration time setting (Pr. 8) is displayed.

Frequency from which deceleration is made in the above set time (Pr. 20 Acceleration/deceleration reference frequency) is displayed.

Still PV. ON?  
Set Too Low?  
Load Too Big?  
Pr. 22 Error?

Estimated cause that actual acceleration/deceleration time is longer than the setting is displayed.

## 4) M.Curr.High (Inverter output current is larger than normal)

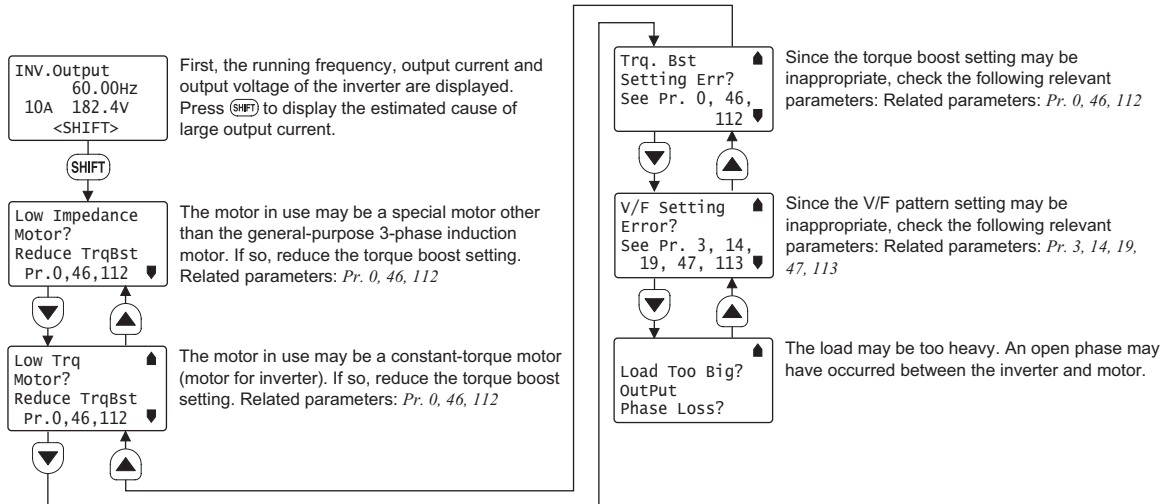

### REMARKS

<When the fault could not be identified>

When the cause of the fault is not specified even after performing the operation mentioned above, the current running frequency, output current and output voltage at the point are displayed on the screen.

Press **(SHIFT)** to display the estimated cause related.

INV. Output  
60.00Hz  
0.00A 182.8V  
<SHIFT>

## 3.2.10 Terminal assignment (Selectop)

The signals assigned to the control circuit terminals and their ON-OFF state are displayed.  
 If the plug-in options FR-A7AX, FR-A7AY and FR-A7AR are mounted, the terminal state of the plug-in option can be also confirmed.

<b>1</b>	Press <b>FUNC</b> . The function menu is called.	<div style="border: 1px solid black; padding: 5px;">                         1 MONITOR                          2 PU Oper                          3 Pr.List                          4 Pr.Clear                     </div>
<b>2</b>	Using <b>▲</b> / <b>▼</b> , move the cursor to "10 Selectop". Hold down <b>SHIFT</b> and press <b>▲</b> / <b>▼</b> to shift one screen.	<div style="border: 1px solid black; padding: 5px;">                         9 S/w                          10 Selectop                          11 Option                          12 PRcPy set                     </div>
<b>3</b>	Press <b>READ</b> . The signals assigned to the control circuit terminals and their ON-OFF states are displayed.	<div style="border: 1px solid black; padding: 5px;">                         RL : 0 □                          RM : 1 □                          RH : 2 □                          RT : 3 □                     </div>

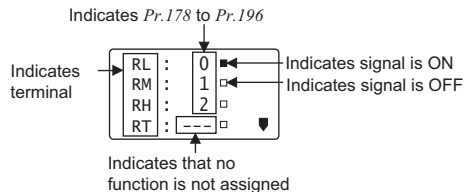





### REMARKS

- Plug-in options cannot be mounted to FR-D700.

### 3.2.11 Option

Displays what options are fitted to the option connectors.

1	<p>Press <b>FUNC</b>.</p> <p>The function menu is called.</p>	<pre>1 MONITOR 2 PU Oper 3 Pr.List 4 Pr.Clear</pre>
2	<p>Using /, move the cursor to "11 Option".</p> <p>Hold down <b>SHIFT</b> and press / to shift one screen.</p>	<pre>9 S/W 10 Selectop 11 Option 12 PRCpy set</pre>
3	<p>Press <b>READ</b>.</p> <p>Numbers OP1 to OP3 correspond to numbers 1 to 3 of the option slot on the inverter side.</p> <p>For the inverter with only one option slot, mounted option is displayed next to OP1.</p> <p>The plug-in option which is mounted on the inverter is displayed.</p>	<pre>&lt;option&gt; OP1: ---- OP2: ---- OP3: A7NC</pre>

#### REMARKS

Plug-in options cannot be mounted to FR-D700.





### 3.2.12 Multiple copies

#### (1) Copying the parameter settings

Parameter settings of an inverter can be read. The settings of maximum three inverters can be stored in the FR-PU07. You can also copy the stored parameter settings to another inverter of the same series.

##### Confirm for setting

- Is the PU operation mode selected? → If not, press  to select the PU operation mode.
- Is the inverter stopped? → If it is running, press  to stop it.
- Is the *Pr. 77* setting of the copy destination inverter correct? → Set "0 or 2" in *Pr. 77*.
- Is the inverter of the copy destination the same series as that of the copy source? → Select the inverter of the same series.  
Example: ○ FR-A720-0.4K → FR-A720-0.75K      Parameters can be copied only to the same series inverters.  
          × FR-A720-0.4K → FR-F720-0.75K

##### CAUTION

Turning power OFF during parameter copy (read, write) as below, processing is not completely ended.

Perform parameter copy again.

- Turn OFF the inverter power.
- Remove the FR-PU07 from the inverter.
- Pull out the PU cable.

- Reading the parameter settings of the inverter and storing them to FR-PU07.

<b>1</b>	Connect the FR-PU07 to the copy source inverter.	
<b>2</b>	Press <b>FUNC</b> . The function menu appears.	1 MONITOR 2 PU Oper 3 Pr. List 4 Pr. Clear ▾
<b>3</b>	Select the "PRCpy set". Using <b>▲</b> / <b>▼</b> , move the cursor to "12 PRCpy set" and press <b>READ</b> .	9 S/W ▲ 10 Selectop 11 Option 12 PRCpy set
<b>4</b>	Select the copy area. The copy area selection screen is displayed. Then, move the cursor to any one of 1 to 3 and press <b>READ</b> . (Parameter settings of each inverter (three inverters in total) can be copied to the area 1, 2 or 3.)	1 Copy area 1 2 Copy area 2 3 Copy area 3
<b>5</b>	Select the "READ". Using <b>▲</b> / <b>▼</b> , move the cursor to "1 Read VFD" and press <b>READ</b> .	Copy area 1 1 Read VFD 2 Write VFD 3 Verifying

<b>6</b>	Give a name. You can name each of copy areas 1 to 3. Select the characters with <b>▲</b> / <b>▼</b> and set them with <b>READ</b> . Press <b>WRITE</b> to set the name for the area.	Name: 012 ▲▼: Select Char READ: Decide Char WRITE: DecideName
<b>7</b>	Write to the copy area of FR-PU07. The screen for confirming the overwriting of the data in the FR-PU07 is displayed.	012 Overwrite area 1 WRITE: Executing ESC: Cancel
<b>8</b>	Press <b>WRITE</b> . The parameter settings of the inverter are stored. When canceling, press <b>ESC</b> .	Param Copy <div style="border: 1px solid black; padding: 2px; display: inline-block; margin-top: 5px;"> <b>Reading</b> Completed                 </div>

- Writing the parameter setting stored in FR-PU07 to the inverter

<b>1</b>	Connect the FR-PU07 to the copy destination inverter.	
<b>2</b>	Press <b>FUNC</b> . The function menu appears.	<div style="border: 1px solid black; padding: 5px;">           1 MONITOR            2 PU Oper            3 Pr.List            4 Pr.Clear         </div>
<b>3</b>	Select the "PRCpy set". Using <b>▲</b> / <b>▼</b> , move the cursor to "12 PRCpy set" and press <b>READ</b> .	<div style="border: 1px solid black; padding: 5px;">           9 S/W            10 Selectop            11 Option            12 PRCpy set         </div>
<b>4</b>	Select the copy area. Point the cursor to the copy area that stores the parameter settings to be written to the inverter, and press <b>READ</b> .	<div style="border: 1px solid black; padding: 5px;">           1 Copy area 1            2 Copy area 2            3 Copy area 3         </div>
<b>5</b>	Select the "WRITE". Using <b>▲</b> / <b>▼</b> , point the cursor to "2 Write VFD" and press <b>READ</b> .	<div style="border: 1px solid black; padding: 5px;">           Copy area 1            1 Read VFD            2 Write VFD            3 Verifying         </div>

<b>6</b>	Writing the parameter settings is selected, and the confirmation screen for writing is displayed.	<div style="border: 1px solid black; padding: 5px;">           012            Area 1 to VFD            WRITE:Executing            ESC:Cancel         </div>
<b>7</b>	Press <b>WRITE</b> . The parameter settings stored in the FR-PU07 are copied to the copy destination inverter.	<div style="border: 1px solid black; padding: 5px;">           Param Copy            Writing  <b>Completed</b>            Please Reset         </div>
<b>8</b>	Reset the inverter. (Refer to page 59)	

## CAUTION

- Overwriting the data of the FR-PU07 deletes the previous data.

## REMARKS

- The parameter settings of three inverters can be stored in areas 1 to 3.
- Read and write cannot be stopped during execution.
- If power is switched OFF, parameter data stored in the parameter unit remains unerasd.

## (2) Verifying the parameters



All the parameter settings stored in the FR-PU07 are verified with those which are stored in the inverter.

### REMARKS

Verification cannot be performed between different inverter series.

1	Refer to <i>page 67</i> and copy the parameter settings of the verify source inverter to the FR-PU07.	
2	Connect the FR-PU07 to the inverter to be verified.	
3	Press <b>FUNC</b> . The function menu appears.	<div style="border: 1px solid black; padding: 5px;"> <p>1 MONITOR 2 PU Oper 3 Pr.List 4 Pr.Clear ▾</p> </div>
4	Select the "multiple copies".  Using <b>▲</b> / <b>▼</b> , move the cursor to "12 PRCpy set" and press <b>READ</b> .	<div style="border: 1px solid black; padding: 5px;"> <p>9 S/w ▲ 10 Selectop 11 Option 12 PRCpy set</p> </div>
5	Select the copy area. Point the cursor to the copy area that stores the parameter settings required verification, and press <b>READ</b> .	<div style="border: 1px solid black; padding: 5px;"> <p>1 Copy area 1 2 Copy area 2 3 Copy area 3</p> </div>

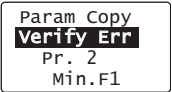
6	Select the "Verifying".  Using <b>▲</b> / <b>▼</b> , point the cursor to "3 Verifying" to press <b>READ</b> .	<div style="border: 1px solid black; padding: 5px;"> <p>Copy area 1 1 Read VFD 2 Write VFD 3 Verifying</p> </div>
7	Verification of the parameter settings is selected, and the confirmation screen for verification is displayed.	<div style="border: 1px solid black; padding: 5px;"> <p>012 Verify Area 1 WRITE:Executing ESC:Cancel</p> </div>
8	Press <b>WRITE</b> .  Start verification of parameter settings stored in the FR-PU07 and parameter settings of the inverter.	<div style="border: 1px solid black; padding: 5px;"> <p>Param Copy <b>Verifying</b> Please wait</p> </div>

9	If an error is detected during verification, the corresponding <i>Pr.</i> is shown. Note that only "Verify Err" will be displayed if an incorrect value has been entered directly (f setting) or set in either <i>Pr. 173</i> or <i>Pr. 174</i> .	
10	Press <b>0</b> . When verification is stopped with verification error, press <b>0</b> to continue verification.	
11	Verification is complete.	

## 3.3 Other Precautions

---

### 3.3.1 Precautions for parameter unit operation

Note the following items when operating the parameter unit to prevent setting from being disabled or incorrect values from being entered.

- **Precautions for the digit count and decimal point of input value**

The maximum number of input digits is six including a decimal point. If you enter a value in excess of 6 digits, the most significant digit is ignored.

12345.6 → ■2345.6  
(Input)    ↑ Ignored

# 4 OPERATION

## 4.1 How to Select the Operation Mode

### 4.1.1 Switching from External operation mode [EXT] to PU operation mode [PU]

#### Confirmation

Make sure that the external input signal (STF, STR) is OFF.

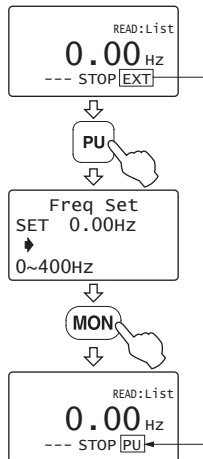

Pressing **[PU]** switches to the PU operation mode and changes the operation mode indication to [PU].

### 4.1.2 Switching from PU operation mode [PU] to External operation mode [EXT]

#### Confirmation

Make sure that the external input signal (STF, STR) is OFF and that the operation command indication is "- - -".

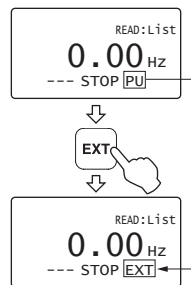





Pressing **[EXT]** switches to the External operation mode and changes the operation mode indication to [EXT].

### 4.1.3 Switching to the External / PU combined operation mode

Changing the *Pr. 79 Operation mode selection* setting to "3" or "4" switches to the External / PU combined operation mode. "PU+E" is displayed in the operation mode indication position.



The relationship between the running frequency and the start signal is as indicated in the following table.

Pr. 79 Setting	Description	
	Running frequency setting	Start signal
3	Parameter unit · Direct setting and  /  key setting External signal input · Multi-speed selection ( <i>Pr. 4 to Pr. 6, Pr. 24 to Pr. 27</i> ) · 4 to 20mADC across terminals 4-5	External signal input · Terminal STF · Terminal STR
4	External signal input · 0 to 5/10VDC across terminals 2-5 · 4 to 20mADC across terminals 4-5 · Multi-speed selection ( <i>Pr. 4 to Pr. 6, Pr. 24 to Pr. 27</i> ) · JOG frequency ( <i>Pr. 15</i> )	Parameter unit ·  · 

#### REMARKS

If the operation mode cannot be switched properly, check the following:

- Make sure that the external input signal is OFF. If it is ON, the operation mode (STF or STR signal) cannot be switched properly.
- Confirm the *Pr. 79 Operation mode selection* setting.  
(Refer to *page 72* and *the inverter instruction manual* )



## 4.2 How to Operate PU Operation

### 4.2.1 Normal operation

During motor operation, the speed can be changed by simply executing Step 2.

Step	Operation Procedure	Image
1	Switch power ON. Make sure that the monitor appears.	
2	Set the running frequency. Set the running frequency using direct setting or step setting. (Refer to page 20)	
3	Press <b>FWD</b> or <b>REV</b> . The motor starts running. The parameter unit automatically enters the monitoring mode and shows the output frequency.	

Step	Operation Procedure	Image
4	Press <b>STOP RESET</b> . The motor is decelerated to a stop.	

#### REMARKS

- When performing PU operation to run the motor, pressing the start key (**FWD** or **REV**) after setting the running frequency switches to monitor mode automatically.

## 4.2.2 PU Jog operation

Hold down **FWD** or **REV** to perform operation, and release it to stop.

Jog operation cannot be performed in the following cases:

- During motor operation
- The *Pr. 15 Jog frequency* is less than the *Pr. 13 Starting frequency*.

Example: To operate at the PU Jog running frequency of 8Hz

Step	Operation Procedure	Image
1	Switch to the PU operation mode. If the operation mode indication is not [PU], refer to <i>page 72</i> and switch to the PU operation mode.	
2	The frequency for Jog operation can be set with <i>Pr. 15 Jog frequency</i> and the acceleration/deceleration time with <i>Pr. 16 Jog acceleration/deceleration time</i> both in the parameter unit. (Refer to <i>page 23</i> for the parameter setting method.) <Initial value> · <i>Pr. 15</i> 5Hz · <i>Pr. 16</i> 0.5s	



Step	Operation Procedure	Image
3	Press <b>PU</b> , then <b>SHIFT</b> . The PU Jog operation mode is selected, and the PU Jog frequency setting screen appears on the display. To change the frequency, enter the value and press <b>WRITE</b> .	
4	Press <b>FWD</b> or <b>REV</b> . The display changes to the monitor screen. Hold down the key to perform operation and release it to stop.	
5	Press <b>PU</b> . The inverter exits from the Jog operation mode and returns to the ordinary PU operation mode.	

### REMARKS

- The Jog operation mode may also be selected from **FUNC**. (Refer to *page 51*)

## 4.3 Combined Operation (Operation Using External Input Signals and PU)

### 4.3.1 Entering the start signal from outside and setting the running frequency from the PU (Pr. 79 = 3)

The external frequency setting signals and  and  of the parameter unit are not accepted.

Stop with  is valid when Pr. 75 Reset selection/disconnected PU detection/PU stop selection = "14 to 17".

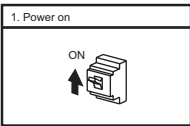
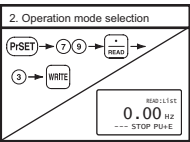
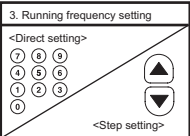
Step	Operation Procedure	Image
1	Switch the power ON.	
2	Set "3" in Pr. 79 Operation mode selection . The External/PU combined operation mode is selected and the operation mode indication on the display changes to "PU + E".	
3	Set the running frequency. Set the running frequency using direct setting or step setting. (Refer to page 20)	

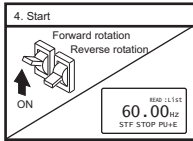
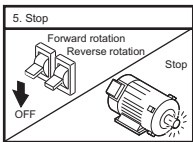
Step	Operation Procedure	Image
4	Set the start switch (STF or STR) to ON. The operation command indication changes to "STF" or "STR" and the operation status indication changes to the output (FWD or REV) indication. · If the forward and reverse rotation switches are both set to ON, the inverter will not start. Also, if these switches are both set to ON during operation, the motor is decelerated to a stop.	
5	Set the start switch (STF or STR) to OFF. The motor stops running.	

### 4.3.2 Entering the running frequency from outside and making start and stop from the PU (Pr. 79 = 4)

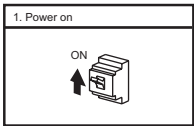
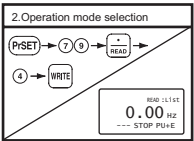
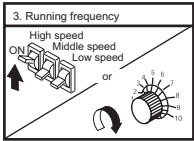
Step	Operation Procedure	Image
1	Switch the power ON.	 <p>1. Power on</p>
2	Set "4" in Pr. 79 Operation mode selection. The External/PU combined operation mode is selected and the operation mode indication on the display changes to "PU + E".	 <p>2. Operation mode selection</p>
3	Enter the external frequency command. Select the multi-speed signal or turn the frequency setting potentiometer.	 <p>3. Running frequency</p>

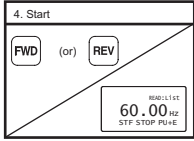
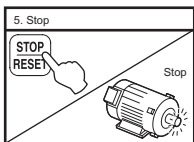
Step	Operation Procedure	Image
4	Press <b>FWD</b> or <b>REV</b> of the parameter unit. The motor starts running, and the state of the output frequency is shown on the display. ·The starting terminals (STF, STR) of the inverter are invalid. ·The inverter may also be started by pressing the PU <b>FWD</b> or <b>REV</b> and then inputting the frequency command.	 <p>4. Start</p>
5	Press <b>STOP RESE</b> of the parameter unit. The motor is decelerated to a stop.	 <p>5. Stop</p>

## 4.3.3 Entering the start signal and multi-speed signal from outside and setting multiple speeds from the parameter unit

Step	Operation Procedure	Image
1	Switch the power ON.	
2	Select the multi-speed signal required for operation. Switch the RH, RM or RL signal ON.	
3	Set the start switch (STF or STR signal) to ON. The operation command indication changes to "STF" or "STR", the operation status indication changes to the output (FWD or REV) indication, and the motor starts running. · If the forward and reverse rotation switches are both set to ON, the inverter will not start. Also, if these switches are both set to ON during operation, the motor is decelerated to a stop.	

Step	Operation Procedure	Image
4	Change the multi-speed frequency during operation from the parameter unit. When high speed has been selected (RH signal ON), changing the Pr: 4 Multi-speed setting (high speed) value varies the speed. · The other multiple-speed settings not being used may also be changed during operation.	
5	Switch off the multi-speed signal (RH, RM or RL signal) and set the start switch (STF or STR signal) to OFF. The motor stops running.	

# 5 CHECK FIRST WHEN YOU HAVE A TROUBLE

## 5.1 Troubleshooting

If a fault occurs and the inverter fails to operate properly, locate the cause of the fault and take proper corrective action by referring to the troubleshooting below. If the corresponding information is not found in the table, the inverter has problem, or the component parts are damaged, contact your sales representative.

Status	Possible causes	Check point	Corrective action
The LCD or backlight of the parameter unit does not light.	Connection fault of the parameter unit	Check that the parameter unit is connected properly. Or check that the PU cable is inserted far into the PU connector.	Check the connection of the parameter unit and the PU cable.
	The setting of <i>Pr. 991 PU contrast adjustment</i> is changed from the initial value.	Check the <i>Pr. 991</i> setting.	Return the <i>Pr. 991</i> setting to the initial value using the operation panel.
	The inverter is in the standby status.	The inverter is in the standby status.	Check whether the PU cable is disconnected.
Check whether the RES signal of the inverter is ON.			Turn OFF the RES signal of the inverter.
The "MITSUBISHI" display remains on and it will not accept operation.	During inverter reset	Check whether RES signal is ON	Turn OFF the RES signal.
	Connection fault of a cable or connector	Check that no cable damage nor connection fault of a connector is found.	Replacement of a cable Check for a connector connection

# 6 SPECIFICATIONS

## 6.1 Standard Specifications

Item	Specifications
Surrounding air temperature	-10°C to +50°C (non-freezing) *1
Ambient humidity	90%RH or less (non-condensing)
Storage temperature	-20°C to +65°C *2
Ambience	Indoors (free from corrosive gas, flammable gas, oil mist, dust and dirt)
Altitude, vibration	Maximum 1000m above sea level for standard operation. 5.9m/s <sup>2</sup> or less at 10 to 55Hz (directions of X, Y, Z axes)
Power supply	Power is supplied from the inverter.
Connection	Installed to the inverter or connected to the inverter by the cable.
Display	LCD (liquid crystal display, 16 characters 4 lines)
Data retention	Onboard EEPROM
Number of write times	Maximum 100,000 times
Mass	Approx. 200g

\*1 At the low temperatures of less than about 0°C, the liquid crystal display (LCD) may be slower in operation.  
At high temperatures, the LCD life may become shorter.

\*2 Temperatures applicable for a short time, e.g. in transit.

### CAUTION

1. Do not expose the liquid crystal screen to direct sunlight.
2. During transportation, avoid applying load to the liquid crystal display.

## 6.2 Outline Drawing and Panel Cutting Drawing

### 6.2.1 FR-PU07 outline dimension drawings

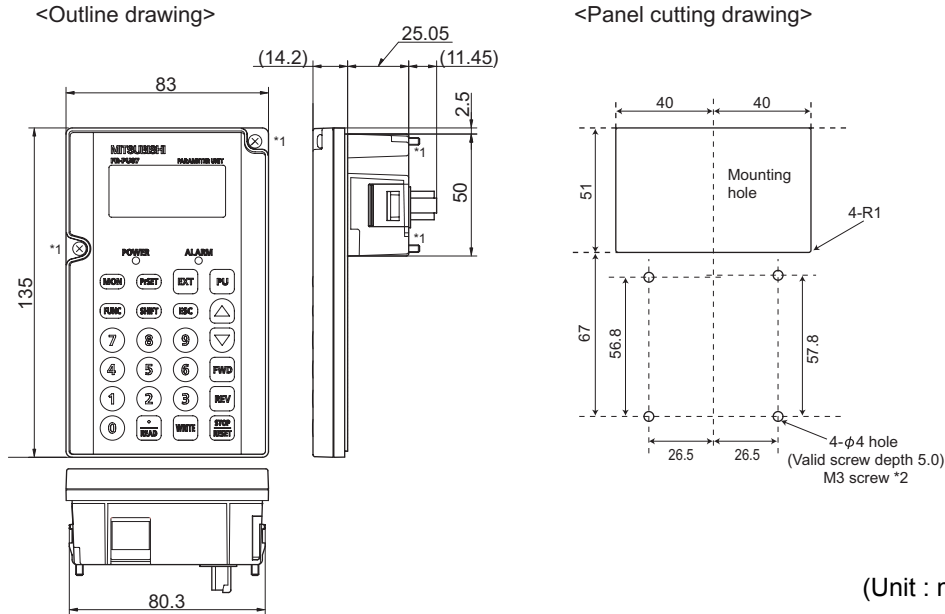

- \*1 When installing the FR-PU07 on the enclosure, etc., remove screws for fixing the FR-PU07 to the inverter or fix the screws to the FR-PU07 with M3 nuts.
- \*2 Select the installation screws of which length will not exceed the effective depth of the installation screws threads.



## Appendix 1 Disposing of the equipment in the EU countries

---

- The symbol shown below, which is printed on the product for EU countries, means that electric and electronic equipment, at their end-of-life, should be disposed of separately from your household waste.
- Please, dispose of this equipment at your local community waste collection/recycling centre if it is to be disposed of in EU countries.
- In the European Union, there are separate collection systems for used electrical and electronic product.
- Please, help us to conserve the environment we live in.

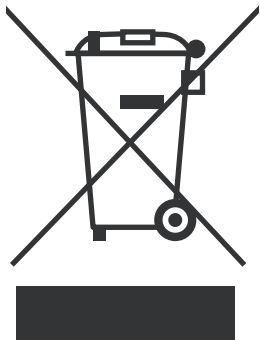

Note: This symbol is for EU countries only.

This symbol is according to the directive 2006/66/EC Article 20 Information for end-users, Article 21 Labelling, and Annex II.

# MEMO

## REVISIONS

\*The manual number is given on the bottom left of the back cover.

<b>Print Date</b>	<b>*Manual Number</b>	<b>Revision</b>
May 2010	IB(NA)-0600421ENG-A	First edition
Feb. 2012	IB(NA)-0600421ENG-B	<b>Addition</b> • FR-F700-EC series

# INVERTER



IB(NA)-0600421ENG-B(1202) MEE

Printed in Japan

Specifications subject to change without notice.